



## 4K MEMORY CARD CAMERA RECORDER

# GY-HC550U/GY-HC550E

# GY-HC500U/GY-HC500E/GY-HC500SPCU

## INSTRUCTIONS (BASIC)

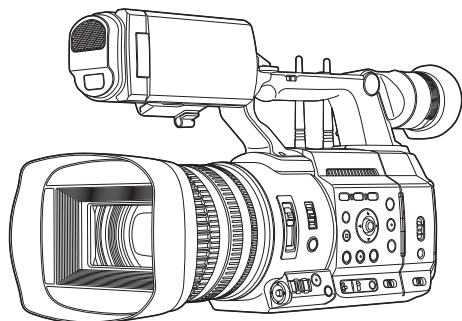

## HDMI™

HIGH DEFINITION MULTIMEDIA INTERFACE

This manual provides a brief explanation on operating this camera recorder. For detailed operation methods and camera settings, please refer to the following Mobile User Guide.

## CONNECTED CAM™

Wireless LAN antenna is not included in GY-HC500U/GY-HC500E/GY-HC500SPCU.

The specifications and appearance of this product are subject to changes for further improvement without prior notice.

Please check the latest version of the INSTRUCTIONS from the following Mobile User Guide.

You can also download the PDF from the Mobile User Guide.

### Mobile User Guide

When you are outside, you can refer to the instructions from your Android phone or iPhone.

<http://manual3.jvckenwood.com/pro/mobile/global/>

You can view the Mobile User Guide using the browser on your Android phone or iPhone.



#### For Customer Use:

Enter below the Serial No. which is located on the body.

Retain this information for future reference.

Model No. GY-HC550U/GY-HC500U/  
GY-HC500SPCU

Serial No. \_\_\_\_\_

#### Please read the following before getting started:

Thank you for purchasing this product.

Before operating this unit, please read the instructions carefully to ensure the best possible performance.

In this manual, each model number is described without the last letter (U/E) which means the shipping destination.

(U: for USA and Canada, E: for Europe)

Only "U" models (GY-HC550U/GY-HC500U/GY-HC500SPCU) have been evaluated by UL.

**FOR USA**

These are general Important Safety Instructions and certain items may not apply to all appliances.

**Important Safety Instructions**

1. Read these instructions.
2. Keep these instructions.
3. Heed all warnings.
4. Follow all instructions.
5. Do not use this apparatus near water.
6. Clean only with dry cloth.
7. Do not block any ventilation openings. Install in accordance with the manufacturer's instructions.
8. Do not install near any heat sources such as radiators, heat registers, stoves, or other apparatus (including amplifiers) that produce heat.
9. Protect the power cord from being walked on or pinched particularly at plugs, convenience receptacles, and the point where they exit from the apparatus.
10. Only use attachments/accessories specified by the manufacturer.
11. Use only with the cart, stand, tripod, bracket, or table specified by the manufacturer, or sold with the apparatus.  
When a cart is used, use caution when moving the cart/apparatus combination to avoid injury from tip-over.
12. Unplug this apparatus during lightning storms or when unused for long periods of time.
13. Refer all servicing to qualified service personnel.  
Servicing is required when the apparatus has been damaged in any way, such as power-supply cord or plug is damaged, liquid has been spilled or objects have fallen into the apparatus, the apparatus has been exposed to rain or moisture, does not operate normally, or has been dropped.

**For USA-California Only**

This product contains a CR Coin Cell Lithium Battery which contains Perchlorate Material – special handling may apply.

See [www.dtsc.ca.gov/hazardouswaste/perchlorate](http://www.dtsc.ca.gov/hazardouswaste/perchlorate)

## POUR LES ÉTATS-UNIS

Ces informations sont des **CONSIGNES DE SÉCURITÉ IMPORTANTES** et certains points peuvent ne pas s'appliquer à tous les appareils.

### CONSIGNES DE SÉCURITÉ IMPORTANTES

1. Lire ces instructions.
2. Conserver ces instructions.
3. Tenir compte de tous les avertissements.
4. Respecter toutes les instructions.
5. Ne pas utiliser cet appareil à proximité de l'eau.
6. Ne nettoyer qu'avec un chiffon sec.
7. Ne pas boucher les ouvertures de ventilation.  
Installer selon les instructions du fabricant.
8. Ne pas installer à proximité de sources de chaleur telles que des radiateurs, des accumulateurs de chaleur, des poêles, ou d'autres appareils (comprenant les amplificateurs) qui produisent de la chaleur.
9. Protéger le cordon d'alimentation pour éviter qu'il ne soit piétiné ou ne se coince, tout particulièrement au niveau de la fiche, de la prise de courant et du point où il sort de l'appareil.
10. Utiliser uniquement des équipements/accessoires spécifiés par le fabricant.
11. N'utiliser qu'avec le chariot, le stand, le trépied, le support ou la table spécifié par le fabricant, ou vendu avec l'appareil.  
Lorsqu'un chariot est utilisé, faire attention pour déplacer la combinaison chariot/appareil pour éviter des blessures causées par un basculement.
12. Débrancher cet appareil pendant un orage ou quand il n'est pas utilisé pendant une longue durée.
13. L'entretien ou la réparation de l'appareil doit être effectué par du personnel qualifié uniquement. Un dépannage est nécessaire lorsque l'appareil a été endommagé d'une façon ou d'une autre, telle que lorsque le cordon d'alimentation ou la fiche est endommagé, si du liquide a été renversé ou si des objets sont tombés à l'intérieur de l'appareil, si l'appareil a été exposé à la pluie ou à l'humidité, ne fonctionne pas normalement ou a fait une chute.



#### **Pour Californie des États-Unis seulement**

Cet appareil contient une pile-bouton CR au lithium qui contient du perchlorate – une manipulation spéciale peut être requise.

Voir [www.dtsc.ca.gov/hazardouswaste/perchlorate](http://www.dtsc.ca.gov/hazardouswaste/perchlorate)

# Safety Precautions

## FOR USA AND CANADA



### CAUTION

RISK OF ELECTRIC SHOCK  
DO NOT OPEN



**CAUTION:**  
TO REDUCE THE RISK OF ELECTRIC SHOCK. DO NOT REMOVE COVER (OR BACK). NO USER-SERVICEABLE PARTS INSIDE. REFER SERVICING TO QUALIFIED SERVICE PERSONNEL.



The lightning flash with arrowhead symbol, within an equilateral triangle is intended to alert the user to the presence of uninsulated “dangerous voltage” within the product’s enclosure that may be of sufficient magnitude to constitute a risk of electric shock to persons.



The exclamation point within an equilateral triangle is intended to alert the user to the presence of important operating and maintenance (servicing) instructions in the literature accompanying the appliance.

## POUR CANADA



### ATTENTION

RISQUE  
D'ELECTROCUTION  
NE PAS OUVRIR



**ATTENTION:**  
POUR EVITER TOUT RISQUE D'ELECTROCUTION NE PAS OUVRIR LE BOITIER. AUCUNE PIECE INTERIEURE N'EST A REGLER PAR L'UTILISATEUR. SE REFERER A UN AGENT QUALIFIE EN CAS DE PROBLEME.



Le symbole de l'éclair à l'intérieur d'un triangle équilatéral est destiné à alerter l'utilisateur sur la présence d'une “tension dangereuse” non isolée dans le boîtier du produit. Cette tension est suffisante pour provoquer l'électrocution de personnes.



Le point d'exclamation à l'intérieur d'un triangle équilatéral est destiné à alerter l'utilisateur sur la présence d'opérations d'entretien importantes au sujet desquelles des renseignements se trouvent dans le manuel d'instructions.

Ces symboles ne sont utilisés qu'aux Etats-Unis.

## Supplier's Declaration of Conformity

Model Number: GY-HC550U  
 GY-HC500U  
 GY-HC500SPCU

Trade Name: JVC

Responsible Party: JVCKENWOOD USA Corporation

Address: 500 Valley Road,  
 Suite 203 Wayne,  
 NJ 07470

Telephone Number: 973-317-5000

This device complies with Part 15 of FCC Rules. Operation is subject to the following two conditions: (1) This device may not cause harmful interference, and (2) this device must accept any interference received, including interference that may cause undesired operation.

Changes or modifications not approved by JVC could void the user's authority to operate the equipment. This equipment has been tested and found to comply with the limits for a Class A digital device, pursuant to Part 15 of the FCC Rules. These limits are designed to provide reasonable protection against harmful interference when the equipment is operated in a commercial environment.

This equipment generates, uses, and can radiate radio frequency energy and, if not installed and used in accordance with the instructions, may cause harmful interference to radio communications. Operation of this equipment in a residential area is likely to cause harmful interference in which case the user will be required to correct the interference at his own expense.

## Déclaration de conformité du fournisseur

Numéro de modèle : GY-HC550U  
 GY-HC500U  
 GY-HC500SPCU

Nom de marque : JVC

Personne responsable : JVCKENWOOD USA Corporation

Adresse : 500 Valley Road,  
 Suite 203 Wayne,  
 NJ 07470

Numéro de téléphone : 973-317-5000

Cet ensemble se conforme à la partie 15 des règles de la FCC (Federal Communications Commission). Le fonctionnement est sujet aux deux conditions suivantes : (1) Cet appareil ne peut pas causer d'interférences nuisibles, et (2) cet appareil doit accepter toute interférence reçue, comprenant des interférences qui peuvent causer un mauvais fonctionnement.

Des changements ou modifications non approuvés par JVC peuvent annuler le droit de l'utilisateur de faire fonctionner l'appareil. Cet appareil a été testé et il a été reconnu qu'il se conforme aux limites concernant l'appareillage informatique de classe A correspondant à la partie 15 des règles de la FCC. Ces limites sont conçues pour fournir une protection raisonnable contre les interférences dangereuses lorsque l'équipement est utilisé dans un environnement commercial.

Cet appareil génère, utilise et peut émettre de l'énergie des fréquences radio et, s'il n'est pas installé et utilisé selon les instructions du fabricant, peut causer des interférences nuisibles en communications radio. L'utilisation de cet équipement dans une zone résidentielle est susceptible de causer des interférences néfastes, auquel cas l'utilisateur devra prendre des mesures à ses propres frais.

**CAUTION:**

The mains plug shall remain readily operable.

- Remove the mains plug immediately if the camera functions abnormally.

**WARNING:**

The battery pack, the camera with battery installed, and the remote control with battery installed should not be exposed to excessive heat such as direct sunlight, fire or the like.

**WARNING: TO PREVENT FIRE OR SHOCK HAZARD, DO NOT EXPOSE THIS UNIT TO RAIN OR MOISTURE.**

**NOTES:**

- The rating plate and safety caution are on the bottom and/or the back of the main unit.
- The serial number plate is on the bottom of the unit.
- The rating information and safety caution of the AC adapter are on its upper and lower sides.

**Caution on Replaceable lithium battery**

The battery used in this device may present a fire or chemical burn hazard if mistreated.

Do not recharge, disassemble, heat above 100°C (212°F) or incinerate.

Replace battery with Panasonic, Sanyo, Sony or Maxell CR2025.

Danger of explosion or risk of fire if the battery is incorrectly replaced.

- Dispose of used battery promptly.
- Keep away from children.
- Do not disassemble and do not dispose of in fire.

**Attention:**

La prise secteur doit être opérationnelle.

- Débranchez immédiatement la fiche secteur si le caméscope ne fonctionne pas normalement.

**Avertissement:**

Évitez d'exposer la batterie, le caméscope avec la batterie insérée ou la télécommande avec la batterie insérée à une chaleur excessive, telle que celle des rayons directs du soleil, d'un feu ou de tout autre source de chaleur.

**AVERTISSEMENT : POUR EVITER LES RISQUES D'INCENDIE OU D'ELECTROCUTION, NE PAS EXPOSER L'APPAREIL A LA PLUIE NI A L'HUMIDITE.**

**REMARQUES :**

- La plaque d'identification et l'avertissement de sécurité se trouvent sous l'appareil et/ou au dos.
- La plaque du numéro de série est située sur la partie inférieure de l'appareil.
- Les informations d'identification et l'avertissement de sécurité de l'adaptateur secteur sont situés sur ses côtés supérieur et inférieur.

**Avertissement sur la pile au lithium remplaçable**

La pile utilisée dans cet appareil peut présenter des risques d'incendie ou de brûlure chimique si elle est mal traitée.

Ne pas recharger, démonter, chauffer à plus de 100°C (212°F) ni mettre au feu.

Remplacez la pile avec Panasonic, Sanyo, Sony ou Maxell CR2025.

Danger d'explosion ou risque d'incendie si la pile n'est pas changée correctement.

- Jeter immédiatement les piles usées.
- Placer hors de la portée des enfants.
- Ne pas démonter ni jeter au feu.

When the equipment is installed in a cabinet or on a shelf, make sure that it has sufficient space on all sides to allow for ventilation (10 cm (3-15/16") or more on both sides, on top and at the rear). Do not block the ventilation holes. (If the ventilation holes are blocked by a newspaper, or cloth etc. the heat may not be able to get out.) No naked flame sources, such as lighted candles, should be placed on the apparatus. When discarding batteries, environmental problems must be considered and the local rules or laws governing the disposal of these batteries must be followed strictly.

The apparatus shall not be exposed to dripping or splashing and that no objects filled with liquids, such as vases, shall be placed on the apparatus.

Do not point the lens directly into the sun. This can cause eye injuries, as well as lead to the malfunctioning of internal circuitry. There is also a risk of fire or electric shock.

### **CAUTION!**

The following notes concern possible physical damage to this unit and to the user.

Carrying or holding this unit by the LCD monitor can result in dropping the unit, or in a malfunction.

Do not use a tripod on unsteady or uneven surfaces. It could tip over, causing serious damage to the unit.

### **CAUTION!**

Connecting cables (Audio/Video, etc.) to this unit and leaving it on top of the TV is not recommended, as tripping on the cables will cause the unit to fall, resulting in damage.

Si le matériel est installé dans un coffret ou sur une étagère, s'assurer qu'il y a un espace suffisant sur tous les côtés pour permettre la ventilation (10 cm (3-15/16") ou plus sur les deux côtés, au dessus et à l'arrière).

Ne pas boucher les orifices de ventilation.

(Si les orifices de ventilation sont bouchés par un journal, un tissu, etc., la chaleur peut ne pas s'éliminer.)

Aucune source à flamme nue, telle que des bougies allumées, ne doit être placée sur l'appareil.

En jetant des batteries aux ordures, les problèmes d'environnement doivent être pris en considération et les réglementations locales ou la législation concernant le rebut de ces batteries doivent être strictement respectées.

L'appareil ne doit pas être exposé à de l'eau ou à des éclaboussures et les objets remplis de liquide, tels que des vases, ne doivent pas être placés sur l'appareil.

Ne dirigez pas l'objectif directement vers le soleil. Vous pourriez vous abîmer la vue et l'appareil pourrait être endommagé. Il y a aussi risque d'incendie ou d'électrocution.

### **Attention!**

Les remarques suivantes sont destinées à protéger l'utilisateur et le caméscope contre des dommages éventuels.

Ne pas transporter ou saisir le caméscope par l'écran LCD, car il pourrait tomber ou s'endommager.

Ne pas utiliser de trépied photographique sur des surfaces irrégulières et inclinées. Il pourrait tomber et le caméscope pourrait être sérieusement endommagé.

### **Attention!**

Avec des câbles (Audio/Vidéo, etc.) raccordés, il est recommandé de ne pas laisser le caméscope sur le dessus du téléviseur, car tirer sur les câbles pourrait faire tomber le caméscope, causant des dommages.

**Warning**

This JVC camera generates RF EME while transmitting. RF EME (Radio Frequency Electric & Magnetic Energy) has the potential to cause slight thermal, or heating effects to any part of your body less than the recommended distance from this radio transmitter's antenna. RF energy exposure is determined primarily by the distance to and the power of the transmitting device. In general, RF exposure is minimized when the lowest possible power is used or transmission time is kept to the minimum required for consistent communications, and the greatest distance possible from the antenna to the body is maintained.

The following list provides you with the information required to ensure that you are aware of RF exposure.

- While transmitting, always keep the antenna and the radio at least 5 cm (1-31/32") from your body or face, as well as from any bystanders.
- To maintain compliance with FCC's RF exposure guidelines, use only the supplied antenna (with antenna holder). Unauthorized antenna, modification, or attachments could damage the transmitter and may violate FCC regulations.

**Electromagnetic Interference Compatibility**

Electronic devices are susceptible to electromagnetic interference (EMI) if they are not adequately shielded or designed for electromagnetic compatibility.

Because this product generates RF energy, it can cause interference to such equipment.

- Turn OFF your WLAN where signs are posted to do so. Hospitals and health care facilities use equipment that is sensitive to electromagnetic radiation.
- Turn OFF your product while on board an aircraft when so instructed. Use of the product must be in accordance with airline regulations and/or crew instructions.

**Informations sur la sécurité en présence d'énergie par radiofréquences****Avertissement**

Ce caméscope JVC génère de l'EME par RF lors de la transmission. L'EME par RF (énergie électrique et magnétique par radiofréquences) peut causer de légers effets thermiques ou chauffants sur toute partie de votre corps, lorsque vous trouvez à une distance inférieure à celle recommandée de l'antenne de cet émetteur radio. L'exposition à l'énergie par radiofréquences est principalement déterminée par la distance et la puissance de l'appareil émetteur. En général, l'exposition aux radiofréquences est minimisée lorsqu'on utilise la puissance la plus faible possible ou que le temps de transmission est maintenu au minimum requis pour assurer des communications cohérentes et lorsqu'on maintient la plus grande distance possible entre l'antenne et le corps.

La liste suivante vous fournit les informations dont vous avez besoin pour être sûr d'être informé de l'exposition aux radiofréquences.

- Pendant la transmission, gardez toujours l'antenne et la radio à au moins 5 cm (1-31/32") de votre corps ou de votre visage, ainsi que de toutes les personnes aux alentours.
- Pour maintenir la conformité avec les directives d'exposition RF de la FCC, utilisez uniquement l'antenne fournie (avec support d'antenne). Une antenne, une modification ou des accessoires non autorisés peuvent endommager le transmetteur et enfreindre les réglementations de la FCC.

**Compatibilité aux interférences électromagnétiques**

Les appareils électroniques sont sensibles aux interférences électromagnétiques (EMI) s'ils ne sont pas correctement protégés ou conçus pour une compatibilité électromagnétique.

Étant donné que cet appareil génère de l'énergie par radiofréquences, il peut provoquer des interférences avec ce genre d'équipement.

- Éteignez votre WLAN lorsque des signes vous l'indiquent s'affichent. Les hôpitaux et les établissements de santé utilisent un équipement sensible aux rayonnements électromagnétiques.
- Éteignez votre appareil lorsque vous trouvez à bord d'un avion et qu'on vous le demande. L'utilisation de l'appareil doit être conforme aux règlements de la compagnie aérienne et/ou aux instructions de l'équipage.



**For indoor use only (5150-5250 MHz) in Canada**

There are legal restrictions on the use and outdoor use depending on the country and region. Please be careful not to violate the law.

Data transmission is always initiated by software, which is the passed down through the MAC, through the digital and analog baseband, and finally to the RF chip. Several special packets are initiated by the MAC. These are the only ways the digital baseband portion will turn on the RF transmitter, which it then turns off at the end of the packet. Therefore, the transmitter will be on only while one of the aforementioned packets is being transmitted. In other words, this device automatically discontinues transmission in case of either absence of information to transmit or operational failure.

Frequency Tolerance: 20 ppm

This radio transmitter (6549A-W8997M1216) has been approved by Innovation, Science and Economic Development Canada to operate with the antenna types listed below, with the maximum permissible gain indicated. Antenna types not included in this list that have a gain greater than the maximum gain indicated for any type listed are strictly prohibited use with this device.

Antenna type	Gain	Impedance
Dipole	3.6 dBi (4.9-5.8 GHz)	50 Ω
	1.9 dBi (2.4-2.5 GHz)	

**Pour usage intérieur seulement (5150-5250 MHz) au Canada**

Il existe des restrictions légales concernant l'utilisation générale et extérieure en fonction du pays et de la région. Veuillez à respecter la loi.

La transmission des données est toujours initiée par le logiciel, puis les données sont transmises par l'intermédiaire du MAC, par la bande de base numérique et analogique et, enfin à la puce RF. Plusieurs paquets spéciaux sont initiés par le MAC. Ce sont les seuls moyens pour qu'une de la bande de base numérique active l'émetteur RF, puis désactive celui-ci à la fin du paquet. En conséquence, l'émetteur reste uniquement activé lors de la transmission d'un des paquets susmentionnés. En d'autres termes, ce dispositif interrompt automatiquement toute transmission en cas d'absence d'informations à transmettre ou de défaillance.

Tolérance de fréquence: 20 ppm

Le présent émetteur radio (6549 A-W 8997 M 1216) a été approuvé par Innovation, Sciences et Développement économique Canada pour fonctionner avec les types d'antenne énumérés ci-dessous et ayant un gain admissible maximal. Les types d'antenne non inclus dans cette liste, et dont le gain est supérieur au gain maximal indiqué pour tout type figurant sur la liste, sont strictement interdits pour l'exploitation de l'émetteur.

Types d'antenne	Gain	l'impédance
Dipôle	3.6 dBi (4.9-5.8 GHz)	50 Ω
	1.9 dBi (2.4-2.5 GHz)	

This transmitter must not be co-located or operated in conjunction with any other antenna or transmitter.

This device contains licence-exempt transmitter(s)/receiver(s) that comply with Innovation, Science and Economic Development Canada's licence-exempt RSS(s). Operation is subject to the following two conditions:

- ① This device may not cause interference.
- ② This device must accept any interference, including interference that may cause undesired operation of the device.

The available scientific evidence does not show that any health problems are associated with using low power wireless devices. There is no proof, however, that these low power wireless devices are absolutely safe. Low power Wireless devices emit low levels of radio frequency energy (RF) in the microwave range while being used. Whereas high levels of RF can produce health effects (by heating tissue), exposure of low-level RF that does not produce heating effects causes no known adverse health effects. Many studies of low-level RF exposures have not found any biological effects. Some studies have suggested that some biological effects might occur, but such findings have not been confirmed by additional research.

The RF module, W8997-M1216 has been tested and found to comply with FCC/ISED radiation exposure limits set forth for an uncontrolled environment and meets the FCC radio frequency (RF) Exposure Guidelines and RSS-102 of the ISED radio frequency (RF) Exposure rules.

Cet émetteur ne doit pas être co-localisé ou utilisé en conjonction avec une autre antenne ou un autre émetteur.

L'émetteur/récepteur exempt de licence contenu dans le présent appareil est conforme aux CNR d'Innovation, Sciences et Développement économique Canada applicables aux appareils radio exempts de licence. L'exploitation est autorisée aux deux conditions suivantes :

- ① L'appareil ne doit pas produire de brouillage;
- ② L'appareil doit accepter tout brouillage radioélectrique subi, même si le brouillage est susceptible d'en compromettre le fonctionnement.

Les connaissances scientifiques dont nous disposons n'ont mis en évidence aucun problème de santé associé à l'usage des appareils sans fil à faible puissance. Nous ne sommes cependant pas en mesure de prouver que ces appareils sans fil à faible puissance sont entièrement sans danger. Les appareils sans fil à faible puissance émettent une énergie fréquence radioélectrique (RF) très faible dans le spectre des micro-ondes lorsqu'ils sont utilisés. Alors qu'une dose élevée de RF peut avoir des effets sur la santé (en chauffant les tissus), l'exposition à de faibles RF qui ne produisent pas de chaleur n'a pas de mauvais effets connus sur la santé. De nombreuses études ont été menées sur les expositions aux RF faibles et n'ont découvert aucun effet biologique. Certaines études ont suggéré qu'il pouvait y avoir certains effets biologiques, mais ces résultats n'ont pas été confirmés par des recherches supplémentaires.

Le module RF, W8997-M1216 a été testé et jugé conforme aux limites d'exposition aux rayonnements énoncées pour un environnement non contrôlé et respecte les règles des radioélectriques (RF) de la FCC lignes directrices d'exposition et d'expos

**IMPORTANT (for owners in the U.K.)  
Connection to the mains supply in  
the United Kingdom.  
DO NOT cut off the mains plug from  
this equipment.**

If the plug fitted is not suitable for the power points in your home or the cable is too short to reach a power point, then obtain an appropriate safety approved extension lead or contact the local dealers in your area.

**BE SURE** to replace the fuse only with an identical approved type, as originally fitted, and to replace the fuse cover.

If nonetheless the mains plug is cut off be sure to remove the fuse and dispose of the plug immediately, to avoid possible shock hazard by inadvertent connection to the mains supply.

If this product is not supplied fitted with a mains plug then follow the instructions given below:

**DO NOT** make any connection to the Larger Terminal coded E or Green. The wires in the mains lead are coloured in accordance with the following code:

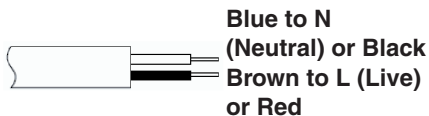

If these colours do not correspond with the terminal identifications of your plug, connect as follows:

Blue wire to terminal coded N (Neutral) or coloured black.

Brown wire to terminal coded L (Live) or coloured Red.

If in doubt — consult a competent electrician.

**CAUTIONS:**

To prevent shock, do not open the cabinet. No user serviceable parts inside. Refer servicing to qualified personnel.

**WARNING**

Operation of this equipment in a residential environment could cause radio interference.

**CAUTION:**

Where there are strong electromagnetic waves or magnetism, for example near a radio or TV transmitter, transformer, motor, etc., the picture and the sound may be disturbed. In such case, please keep the apparatus away from the sources of the disturbance.

The plastics packaging bags may cause suffocation when they are covered over the head. Tear them open, and keep them away from the reach of infants and children by ensuring that they are disposed of properly.

**GY-HC550E**

**Wireless LAN**

- This device is a 2.4 GHz wideband transmission system (transceiver), intended for use in all EU member states and EFTA countries, except in France and Italy where restrictive use applies.
- In Italy the end-user should apply for a license at the national spectrum authorities in order to obtain authorization to use the device for setting up outdoor radio links and/or for supplying public access to telecommunications and/or network services.
- This device may not be used for setting up outdoor radio links in France and in some areas the RF output power may be limited to 10 mW EIRP in the frequency range of 2454 - 2483.5 MHz. For detailed information the end-user should contact the national spectrum authority in France.

Frequency Range	2.4GHz Band : 1 - 13ch
Output Power	11 b/g/n : 14 dBm (max)

Frequency Range	5GHz Band : W52/W53/W56
Output Power	11 n/a/ac : 11 dBm (max)

## GY-HC550E and GY-HC500E

The European representative of JVC KENWOOD Corporation is:

Die europäische Vertretung für die JVC KENWOOD Corporation ist:

JVCKENWOOD Deutschland GmbH  
Konrad-Adenauer-Allee 1-11  
61118 Bad Vilbel  
GERMANY

### GY-HC500E

Dear customer,  
this apparatus is in compliance with the valid European Directive and the relevant standards regarding electromagnetic compatibility.

Sehr geehrter Kunde, sehr geehrte Kundin,  
dieses Gerät stimmt mit der gültigen europäischen Richtlinie und den relevanten Normen bezüglich elektromagnetischer Verträglichkeit überein.

### GY-HC550E

Hereby, JVC KENWOOD Corporation declares that the radio equipment type GY-HC550E is in compliance with Directive 2014/53/EU.  
The full text of the EU declaration of conformity is available at the following internet address:

Hiermit erklärt die JVC KENWOOD Corporation, dass der Funkanlagentyp GY-HC550E der Richtlinie 2014/53/EU entspricht.

Der vollständige Text der EU-Konformitätserklärung ist unter der folgenden Internetadresse verfügbar:



<http://www3.jvckenwood.com/ecdoc/>

### Battery Pack

The supplied battery pack is a lithium-ion battery. Before using the supplied battery pack or an optional battery pack, be sure to read the following cautions:

- **To avoid hazards**
  - ... **do not** burn.
  - ... **do not** short-circuit the terminals. Keep it away from metallic objects when not in use.
  - When transporting, carry the battery in a plastic bag.
  - ... **do not** modify or disassemble.
  - ... **do not** expose the battery to temperatures exceeding 60°C (140°F), as this may cause the battery to overheat, explode or catch fire.
  - ... use only specified chargers.
- **To prevent damage and prolong service life**
  - ... do not subject to unnecessary shock.
  - ... charge within the temperature range of 10°C to 35°C (50°F to 95°F). Cooler temperatures require longer charging time, or in some cases stop charging at all. Warmer temperatures prevent complete charging, or in some cases stop charging at all.
  - ... store in a cool, dry place. Extended exposure to high temperatures will increase natural discharge and shorten service life.
  - ... keep a 30% battery level () if the battery pack is not to be used for a long period of time.
  - ... remove from charger or powered unit when not in use, as some machines use current even when switched off.
  - ... do not drop or subject to strong impact.

#### Terminals

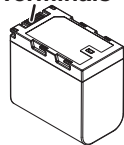

## ■ Para Brasil

### Informação sobre eliminação de baterias

Este produto não deverá ser eliminado como lixo doméstico em geral.

Devolva a bateria velha ao comerciante ou para a rede autorizada, para que seja devolvida ao fabricante ou importador.

A reciclagem e eliminação de lixo em uma maneira adequada, ajudarão para preservar recursos, prevenindo, ao mesmo tempo, contra efeitos prejudiciais sobre a nossa saúde e o meio ambiente.

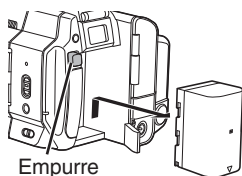

Empurre

### Importer (EU only)

JVCKENWOOD U.K. Limited  
12 Priestley Way, London NW2 7BA,  
UNITED KINGDOM

### Importeur (Nur EU)

JVCKENWOOD Deutschland GmbH  
Konrad-Adenauer-Allee 1-11, 61118 Bad Vilbel,  
DEUTSCHLAND

### Importatore (Solo EU)

JVCKENWOOD Italia S.p.A.  
Via G. Sirtori 7/9, 20129 Milano, ITALIA

### Importeur (Aleen EU)

JVCKENWOOD Belgium N.V.  
Leuvensesteenweg 248J, 1800 Vilvoorde,  
BELGIQUE

### Importeur (Aleen EU)

JVCKENWOOD Europe B.V.  
Amsterdamseweg 37, 1422 AC Uithoorn,  
NEDERLAND

### Manufacturer

### JVCKENWOOD Corporation

3-12, Moriya-cho, Kanagawa-ku, Yokohama-shi,  
Kanagawa, 221-0022, JAPAN

# Contents

## Introduction

Safety Precautions .....	4
Contents .....	14
Verifying the Accessories .....	14
Names of Parts .....	15

## Preparations

Settings and Adjustments Before Use .....	18
Power Supply .....	19
Initial Settings .....	20
Recording Media .....	22

## Shooting

Basic Shooting Procedures .....	26
Miscellaneous Functions for Shooting and Recording Methods .....	27

## Playback

Playing Recorded Clips .....	28
------------------------------	----

## Network

Functions of Network Connection .....	29
Preparing Network Connection .....	30
Connecting to the Network .....	31
Connecting from a Web Browser .....	32

## Others

Menu Screen Hierarchical Chart .....	33
Basic Operations in Menu Screen .....	34
Display Screen in Camera Mode .....	35
Display Screen in Media Mode .....	40
Status Screen .....	42
Troubleshooting .....	43
Precautions for Proper Use .....	45
Specifications .....	48
Software License Agreement .....	53
Important Notice concerning the Software .....	54

## Symbols used

**Caution** : Describes precautions concerning the operation of this product.

**Memo** : Describes reference information, such as functions and usage restrictions of this product.

 : Indicates the reference page numbers and reference items.

**550** : Feature available on GY-HC550U/ GY-HC550E only.

**500** : Feature available on GY-HC500U/ GY-HC500E/GY-HC500SPCU only.

**SPC** : Feature available on GY-HC500SPCU only.

## Verifying the Accessories

Verify that the following accessories are included with the camera recorder before using.

Accessories	
Warranty Card (U model only)	1
INSTRUCTIONS (BASIC)	1
AC Adapter	1
Power Cord (U model: 1, E model: 2)	
Battery	1
Wireless LAN Antenna <b>550</b>	2

\* A large eyecup and hood are mounted in advance to the camera body.

# Names of Parts

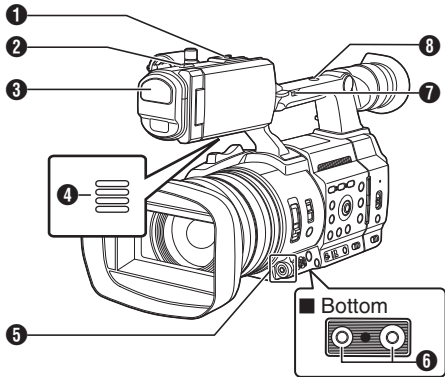

- ❶ Shoe
- ❷ Tally Lamp
- ❸ Built-in Microphone
- ❹ Monitor Speaker
- ❺ Cross-Shaped Button (▲▼◀▶)/Set Button (●)
- ❻ Tripod Mounting Screw Hole
- ❼ [FIX/VAR/OFF] zoom speed switch
- ❽ Accessory Mounting Screw Hole

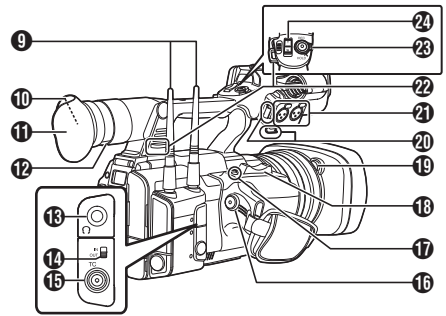

- ❹ Wireless LAN Antenna Terminal 550
- ❺ Viewfinder
- ❻ Eyecup
- ❼ Visibility Adjustment Lever
- ❽ [🎧] Headphone Jack
- ❹ [TC IN/OUT] switch
- ❺ [TC] TC Input/Output Terminal
- ❻ [REC] Record Trigger Button
- ❼ [EXP.FOCUS/9] Expanded Focus Assist/User 9 Button
- ❽ Zoom Lever at the Grip
- ❹ Hood Release Button
- ❺ External Microphone Cable Clamp
- ❹ [INPUT1/INPUT2] Audio Input Terminal 1, 2 (XLR 3-pin x 2)
- ❺ Shoulder Belt Mount (x2)
- ❹ [REC/HOLD] Record Trigger Button/Lock Switch
- ❺ Zoom Lever on Handle

## Side Control Panel

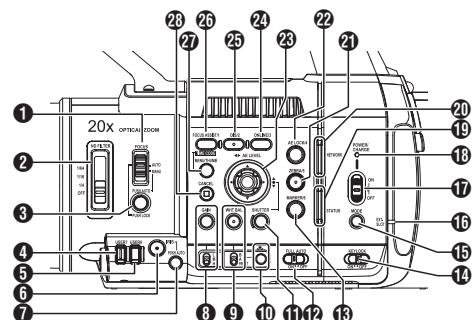

- 1 [FOCUS AUTO/MANU] Focus Switch
- 2 [ND FILTER] ND Filter Switch
- 3 [PUSH AUTO/PUSH LOCK] Focus Push Auto/ Push Lock Button
- 4 [USER7] Button
- 5 [USER8] Button
- 6 [IRIS] Iris Auto/Manual Selection Button
- 7 [PUSH AUTO] Iris Push Auto Button
- 8 [GAIN] Gain Auto/Manual Selection Button / [L/M/H] Sensitivity Selection Switch
- 9 [WHT BAL] White Balance Auto/Manual Selection Button / [B/A/PRESET] Selection Switch
- 10 [One Push Auto White Balance Button]
- 11 [SHUTTER] Shutter Speed Auto/Manual Selection Button
- 12 [FULL AUTO ON/OFF] Full Auto Switch
- 13 [MARKER/6] Marker/User 6 Button
- 14 [KEYLOCK ON/OFF] Key Lock Switch
- 15 [MODE] Camera/Media Mode Selection Button
- 16 EXT.SLOT Lamp
- 17 [POWER ON/OFF] Lock Power ON/OFF Switch
- 18 POWER/CHARGE LED
- 19 STATUS LED
- 20 NETWORK LED
- 21 [ZEBRA/5] Zebra/User 5 Button
- 22 [AE LOCK/4] AE Lock/User 4 Button
- 23 Cross-Shaped Button (▲▼◀▶)/Set Button (●)
- 24 [ONLINE/3] Online/User 3 Button

- 25 [OIS/2] Optical Image Stabilizer/User 2 Button
- 26 [FOCUS ASSIST/1] Focus Assist/User 1 Button
- 27 [MENU/THUMB] Menu/Thumbnail Button
- 28 [CANCEL] Cancel Button

## Rear Terminal

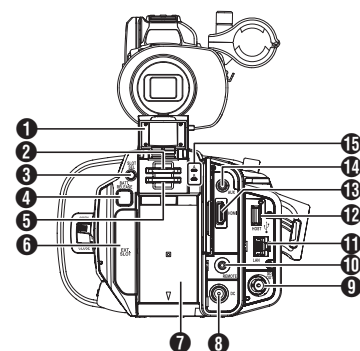

- 1 SD Card Cover
- 2 Card Slot A
- 3 [SLOT SEL] Button
- 4 [BATT.RELEASE] Button
- 5 Card Slot B
- 6 [EXT.SLOT]
- 7 Battery
- 8 [DC] terminal
- 9 [SDI OUT] Terminal
- 10 [REMOTE] terminal
- 11 [LAN] Terminal
- 12 [HOST] USB Host Terminal
- 13 [HDMI] Terminal
- 14 [AUX] terminal
- 15 Access Lamp A/B



## LCD Monitor

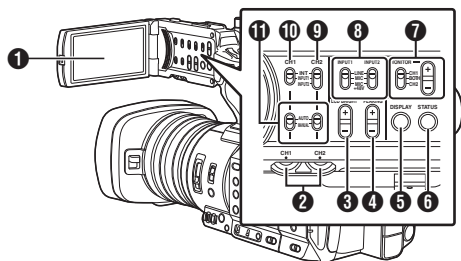

- ❶ LCD Monitor
- ❷ [CH1/CH2] CH1/CH2 Recording Level Adjustment Knob
- ❸ [LCD BRIGHT +/-] LCD Display Brightness Adjustment Button
- ❹ [PEAKING +/-] LCD/VF Contour Adjustment Button
- ❺ [DISPLAY] Display Button
- ❻ [STATUS] Status Screen Display Button
- ❼ [MONITOR]/[+/-] Audio Monitor Selection Switch/Volume Adjustment Button
- ❽ [INPUT1/INPUT2] Audio Input Signal Selection Switch
- ❾ [CH2] CH2 Audio Input Signal Selection Switch
- ❿ [CH1] CH1 Audio Input Signal Selection Switch
- ⓫ [CH1/CH2 AUTO/MANUAL] CH1/CH2 Audio Recording Mode Switch

## Lens Section

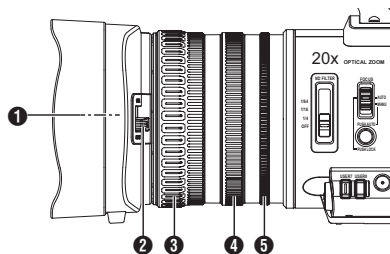

- ❶ Filter Built-In Screw
    - Installable filter types:  $\Phi 82$  mm
- Memo : \_\_\_\_\_
- Remove the lens hood when installing the filter.
- 
- ❷ Lens Cover Open/Close Switch
  - ❸ Focus Ring
  - ❹ Zoom Ring
  - ❺ Iris Ring

# Settings and Adjustments Before Use

## Adjusting the Grip Belt

Open the pad and adjust the position of the grip belt accordingly.

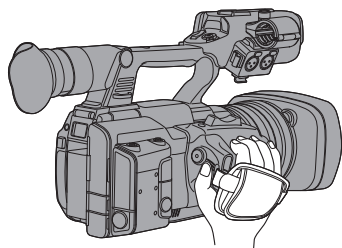

Caution :

- If the grip is loose, the camera recorder may fall off resulting in injuries or malfunction.

## Attaching the External Microphone (Sold Separately)

You can attach a separately sold microphone to the microphone holder.

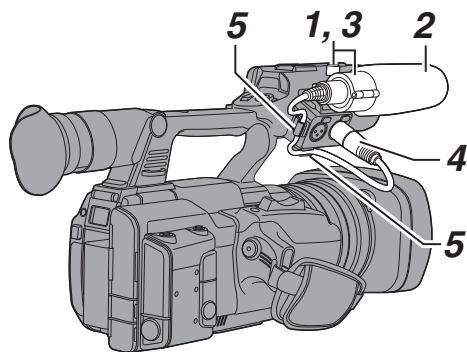

- 1 Turn the knob on the microphone holder counterclockwise to loosen and open the microphone holder.
- 2 Place the microphone in the microphone holder.
- 3 Turn the knob on the microphone holder clockwise to secure the microphone.
- 4 Connect the microphone cable to the [INPUT1] or [INPUT2] terminal.
- 5 Pin the microphone cable to the clamp.
- 6 Perform the settings for the microphone correctly.

## Attaching the Wireless LAN Antenna (Supplied) 550

Attach the wireless LAN antenna by turning it in the clockwise direction. Hold the base while attaching the antenna.

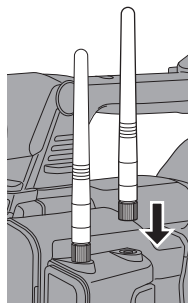

Caution :

- Applying force to the wireless LAN antenna or yanking it may damage the antenna so please use caution when using the antenna. If it is damaged, replacement is chargeable even during the warranty period. (Part number: T9A-0095-00)
- Use the antenna holders without removing them.

## Opening/Closing the Lens Cover

Use the lens cover open/close switch to open or close the lens cover.

Before shooting, open the lens cover.

When this camera recorder is not in use, close the lens cover to protect the lens.

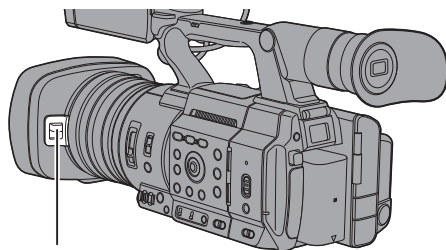

Lens cover switch

Caution :

- Do not press against the lens cover with force. Doing so may damage the lens or the cover.

# Power Supply

To use this camera recorder, you can attach a battery pack or connect an AC adapter to it.

Caution :

- Set the [POWER ON/OFF] switch to "OFF" before changing the power supply that operates this camera recorder.
- To charge the battery using a battery charger, purchase a genuine charger that can charge the recommended battery.

## Using a Battery Pack

### Charging the Battery

Charge the battery immediately after purchase or when the battery power is running low.

\* The battery is not charged when purchased.

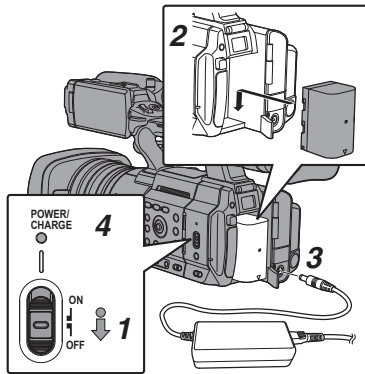

- 1 Hold down the lock button (blue) at the center of the [POWER ON/OFF] switch to set to "OFF".
- 2 Attach the supplied battery. Slide it in until you hear a click.
- 3 Connect the supplied AC adapter to the [DC] terminal. Open the cover of the [DC] terminal and connect as shown in the diagram.
- 4 Connect the AC adapter to a power outlet.
  - The [POWER/CHARGE] lamp blinks during charging and will go out after charging is complete.
  - Remove the AC adapter after charging is complete.

Memo :

- Blinking of the [POWER/CHARGE] lamp during charging indicates the charge level.

[POWER/CHARGE] Lamp during "POWER.OFF"	Charge Level
Alternates between a blinking orange light (4 times) and light off (1 second)	Less than 25 %
Alternates between a blinking orange light (3 times) and light off (1 second)	Less than 50 %
Alternates between a blinking orange light (2 times) and light off (1 second)	Less than 75 %
Alternates between a blinking orange light (blinks once) and light off (1 second)	Less than 100 %
Light goes out	Fully charged

- You can charge the battery even when operating the camera recorder using the AC adapter. The lamp lights up in green during "POWER.ON".

### Removing the Battery

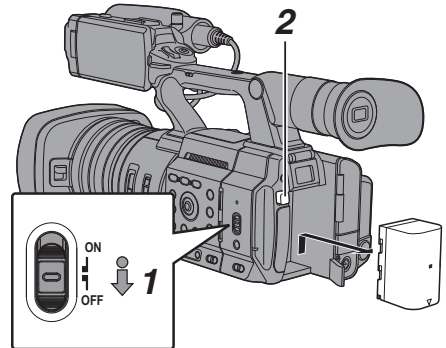

- 1 Hold down the lock button (blue) at the center of the [POWER ON/OFF] switch to set to "OFF".
- 2 While pressing and holding the [BATT. RELEASE] button, push up and remove the battery in the direction of the arrow.

Caution :

- Do not remove the battery when the [POWER ON/OFF] switch is "ON".
- Leaving the camera recorder unused with the battery attached will deplete the battery power even when you set the [POWER ON/OFF] switch to "OFF". Remove the battery if you are not using the camera recorder.

## Estimated Charging and Continuous Operating Times

### ■ Charging time

BN-VC296G (accessory): Approx. 5 hours

\* When the [POWER ON/OFF] switch is set to "OFF"

Memo : \_\_\_\_\_

- If you charge the battery immediately after using while the battery is still warm, it may not be fully charged.
- It is recommended that you charge the battery in an environment between 10 °C and 30 °C (50 °F and 86 °F). The battery may not be fully charged or the charging time may be prolonged if charged under low temperatures (below 10 °C/50 °F). In addition, charging the battery under high temperature (above 30 °C/86 °F) condition may shorten the battery life.

### ■ Continuous operating time

BN-VC296G (accessory): Approx. 2 hrs 40 mins (\*1)  
Approx. 2 hrs 50 mins (\*2)

- \*1 When [System] is set to "4K" and all other settings are in factory default  
\*2 When [System] is set to "HD" and all other settings are in factory default

Memo : \_\_\_\_\_

- Actual operating times may differ depending on the age of the battery, charging condition, and operating environment.
- Operating time is shortened in cold environment.
- The operating time may shorten when power zoom is used, accessories are connected, or when the LCD monitor is frequently used.
- For purchase of spare batteries and battery charger, please contact the local dealers in your area.

## Using AC Power (DC IN Power)

Use the supplied AC adapter to operate the camera recorder with AC power.

## Initial Settings

When the power is first turned on, the Initial Setting screen for performing the initial settings in the camera recorder appears.

Set the date/time of the built-in clock in the [Date/Time] screen.

All operations are disabled until initial settings are complete.

Memo : \_\_\_\_\_

- It is recommended to use the AC adapter as the power supply.
- Be sure to close the lens cover.

### 1 Hold down the lock button (blue) at the center of the [POWER ON/OFF] switch to set to "ON".

A language selection screen appears.

- For U models

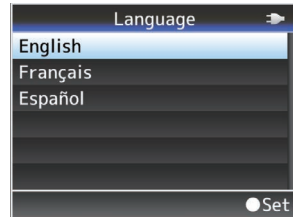

- For E models



Memo : \_\_\_\_\_

- The menus and messages on the screen of the LCD monitor or viewfinder are displayed in the selected language.

- 2 **Select a language using the cross-shaped button (▲▼), and press the Set button (●).**  
A self-diagnosis screen appears.

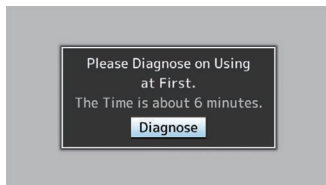

- 3 **Ensure that the lens cover is closed, and press the Set button (●).**

- Self-diagnosis starts.
- A progress bar appears, and “Complete Diagnosis” appears when the diagnosis is complete.

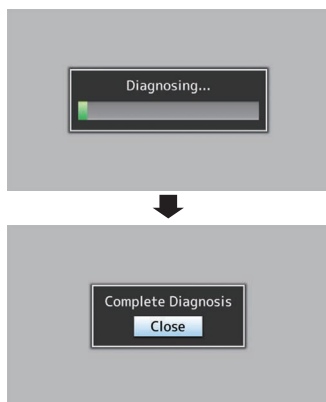

Memo : \_\_\_\_\_

- It takes about 6 minutes to complete the diagnosis. During the diagnosis, do not operate or turn off the camera recorder.

- 4 **Press the Set button (●) after confirming the exit screen.**

The [Date/Time] screen appears.

- For U models

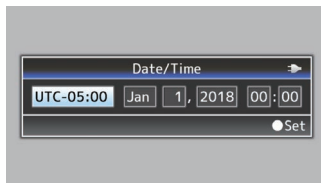

- For E models

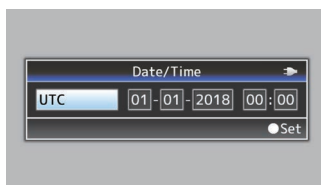

- 5 **Set the time zone and date/time.**

- ① Move the cursor with the cross-shaped button (◀▶) and select the setting item.
- ② Change the values with the cross-shaped button (▲▼).

- 6 **Press the Set button (●) after setting is complete.**

The clock is set to 0 seconds of the input date/time.

Memo : \_\_\_\_\_

- The configured date/time data can be displayed on the LCD monitor and viewfinder screen and be recorded to a recording media.
- The value of the year can be set in the range of “2000” to “2099”.
- The configured date/time data is saved in the built-in battery even if the power is turned off.
- If the date/time data is no longer retained, the built-in battery is dead. For replacement of the built-in battery, please contact the local dealers in your area.

# Recording Media

This camera recorder saves recorded audio sound and videos except those in “4K EXT” quality to the SD card (sold separately) in the card slot. Meanwhile, when the KA-MC100 SSD MEDIA ADAPTER (sold separately) is inserted into [EXT.SLOT], “4K EXT” videos and audio sound are recorded to the SSD media (sold separately).

## Usable Cards

### Format Setting and Usable SD Card Combinations

System	Format	Bit Rate	Usable SD Card
High-Speed		4:2:2 100 70M (XHQ), 4:2:2 100 50M (XHQ), 50M (XHQ), 35M (UHQ)	UHS-I U3 or higher
4K	QuickTime (H.264)	4:2:2 100 150M, 150M 70M	
HD		4:2:2 100 70M (XHQ), 4:2:2 100 50M (XHQ), 50M (XHQ) 35M (UHQ)	UHS-I U1 or higher, or Class 10 or higher
	QuickTime (MPEG2), MXF (MPEG2) 550	35M (HQ), 25M (SP)	UHS-I U1 or higher, or Class 6 or higher
	Exchange (U model)	12M (LP), 8M (LP)	
	MP4 (H.264) (E model)	12M (LP), 8M (LP)	
SD	-	-	UHS-I U1 or higher, or Class 4 or higher
Web	-	-	

Caution :

- Using cards other than those from Panasonic, TOSHIBA or SanDisk may result in recording failure or data loss.

## Usable SSD Media

Refer to the “Instruction Manual” of the SSD MEDIA ADAPTER that is inserted into [EXT.SLOT] for steps to mount the SSD media.

Caution :

- Please refer to the product information page on our website for a list of SSD media that have been tested for compatibility.

## Estimated Recordable Time of SD Cards

The estimated recordable time is only a guide. Differences may occur depending on the SD card in use and the battery condition.

- The recordable time varies according to the settings in [System], [AFormat], [AResolution], [ABit Rate] and [BResolution].

System	4K		
Format	QuickTime (H.264)		
Resolution	3840x2160		
Bit Rate	4:2:2 100 150M	150M	70M
8GB	6	6	13
16GB	12	12	26
32GB	25	25	53
64GB*	50	50	106
128GB*	100	100	212
256GB*	199	200	424
512GB*	399	401	848

\* SDXC (Unit: minute)

System	HD, HD + Web (HD)			SD, HD + Web (Web)	HD+Web (Web)	
Format	QuickTime (H.264)					
Resolution	1920x1080	1920x1080, 1280x720		720x480, 720x576	960x540	480x270
Bit Rate	XHQ (70M)	XHQ (50M)	UHQ	HQ	HQ	LP
8GB	13	18	25	96	274	588
16GB	26	36	51	194	556	1190
32GB	52	73	103	391	1119	2396
64GB*	105	147	207	785	2243	4804
128GB*	210	295	415	1572	4495	9626
256GB*	420	590	832	3147	8998	19270
512GB*	839	1180	1664	6297	18004	38557

\* SDXC (Unit: minute)

System	HD			
Format	QuickTime (MPEG2) <b>550</b> , MXF (MPEG2) <b>550</b>		Exchange, MP4 (H.264)	
	Resolution	1920x1080, 1440x1080, 1280x720	1440x1080	1920x1080
Bit Rate	HQ	SP	LP (12M)	LP (8M)
8GB	25	35	68	97
16GB	51	70	139	197
32GB	103	141	279	396
64GB*	206	283	580	794
128GB*	412	566	1121	1592
256GB*	825	1133	2245	3186
512GB*	1651	2267	4482	6376

\* SDXC (Unit: minute)

Memo : \_\_\_\_\_

- If the SD card contains files recorded by devices other than this camera recorder or files that are saved from a PC, the recordable time may be shorter or data may not be properly recorded.
- For each file format, up to 600 clips can be recorded to one SD card on this camera recorder. When 600 clips are recorded to one card, the remaining space is displayed as 0 min regardless of the estimated recordable time, and no further recording can be performed.
- When [System] is configured to "High-Speed", the remaining time display for recording to the SD card will run out faster than usual.

## Estimated Recordable Time of SSD Media

The estimated recordable time is only a guide. Differences may occur depending on the SSD media in use and condition of the battery.

- The recordable time varies according to the settings in [System], [**EXT** Frame Rate], and [**EXT** Bit Rate].

System	4K EXT					
Format	ProRes					
Resolution	3840x2160					
Frame Rate	60p			50p		
Bit Rate	422HQ	422	422LT	422HQ	422	422LT
500GB	34	50	72	40	60	86
1TB	67	101	144	80	121	173
2TB	134	201	289	161	241	346
Frame Rate	30p			25p		
Bit Rate	422HQ	422	422LT	422HQ	422	422LT
500GB	67	100	144	80	120	172
1TB	134	201	288	161	240	345
2TB	268	402	576	321	481	690
Frame Rate	30p					
Bit Rate	422HQ	422	422LT			
500GB	84	125	180			
1TB	167	251	359			
2TB	335	502	719			

## Inserting an SD Card

This camera recorder comes with two card slots (Slot A and B) for video/audio recording and playback.

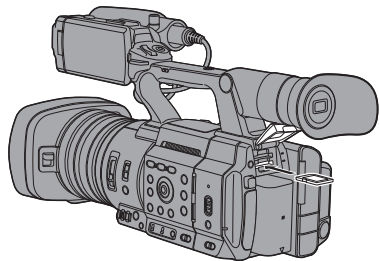

- 1 Open the SD card cover.
- 2 Insert an SD card into the slot with the notched corner of the card on the right.  
The status indicator of the card slot to which the card was inserted lights up in red.
- 3 Close the SD card cover.

## Inserting the SSD MEDIA ADAPTER

This camera recorder comes with an [EXT.SLOT] for recording and playing audio sound and videos in “4K EXT” quality.

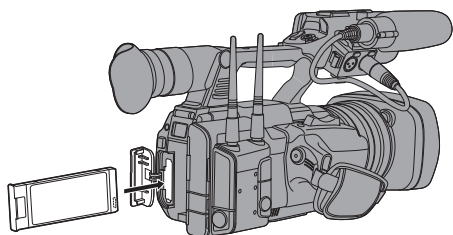

- 1 Turn off the camera recorder.
- 2 Detaching the Battery
- 3 Open the EXT.SLOT cover.
- 4 With the USB terminal of the SSD MEDIA ADAPTER facing down, insert it into [EXT.SLOT].  
Insert it all the way until the tab locks into place.
- 5 Close the EXT.SLOT cover.
- 6 Attach the battery.
- 7 Turn on the camera recorder.

## Formatting (Initializing) of Recording Media

When any of the following recording media (SD card or SSD media) is inserted, [!FORMAT] appears in the remaining level display area. Format the card using the camera recorder menu.

- Unformatted recording media
- Recording media formatted under different specifications

Caution :

- Be sure to format the recording media on this camera recorder. Recording media formatted on a PC or other peripheral equipment cannot be used on this camera recorder.
- [!RESTORE] appears in the remaining level display area when a recording media that requires repair is inserted.

- 1 Select [System] → [Media] → [Format Media].

- 2 Select the slot of the card to be formatted and press the Set button (●).

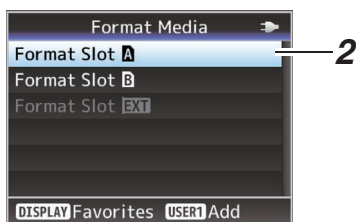

- 3 The status of the selected recording media is displayed.
- 4 Select [Format] and press the Set button (●).

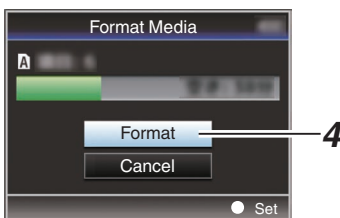

- 5 Formatting starts.

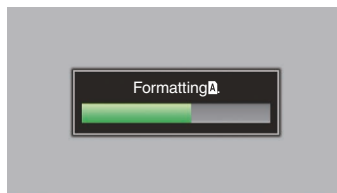

- 6 Formatting is complete.

When formatting is complete, “Complete” appears and the camera recorder returns to the [Format Media] screen.

Memo :

- The menu cannot be operated while formatting is in progress, but recording is possible to the slot where formatting is not executed.
- Formatting cannot be performed in the following cases.
  - When recording to the recording media to be formatted is in progress.
  - SD card is not inserted.
  - Write-protect switch of the SD card is set (🔒 is displayed).

Caution :

- If you format a recording media, all data recorded to it, including video data and setup files, will be deleted.



## Clips Recorded to Recording Media

### Folders Created in the Recording Media

The captured image is recorded into different folders according to the [Format] settings.

- Other than MXF (MPEG2): [DCIM]
- MXF (MPEG2): [PRIVATE] **550**

Memo : \_\_\_\_\_

- By formatting (initializing) the recording media from the [Format Media] menu on the camera recorder, folders required for recording in the current [System] settings will be generated.
- When the [System] settings and [AFormat]/[BFormat] settings are changed, folders required for recording in those settings will be automatically generated.

Caution : \_\_\_\_\_

- When a clip inside the folder is moved or deleted using the Explorer (Windows) or Finder (Mac), recording to the recording media may fail if formatting (initializing) of the media is not performed.

### Clip (Recorded Data) and Clip Name

- When recording is stopped, the images, audio and accompanying data which are recorded from start to stop are recorded as one “clip” on the recording media.
- An 8-character clip name is automatically generated for the recorded clip. (“Clip Name Prefix” + “Clip Number”)

Example: QuickTime

**ABCG0001**

Clip Number  
A number in automatic ascending order is assigned in the recording order.  
The Clip Number can be reset in the menu.\*

Clip Name Prefix (any four alphanumeric characters)  
This is set to “xxxG” (“xxx” denotes the last 3 digits of the serial number) by default.

\* [Clip Set] ➔ [Reset Clip Number]

Memo : \_\_\_\_\_

- Before recording starts, you can set any characters for the clip name prefix by using [System] ➔ [Record Set] ➔ [Clip Set] ➔ [Clip Name Prefix].
- Changes cannot be made after recording.

### Recorded Clips

- The recorded materials may be split into several files but they can be played back continuously on the camera recorder.
- Clips may be recorded across the two SD cards in card slots A and B depending on the recording time of the clip.

Caution : \_\_\_\_\_

- A clip recorded across several SD cards cannot be played back continuously. Continuous playback is only possible when the recording is made on one card.

# Basic Shooting Procedures

## Setting up

- 1 **Supply battery or AC adapter power to the camera recorder.**
- 2 **Insert the recording media**
- 3 **Turn on the power of the camera recorder.**  
Setting the [POWER ON/OFF] switch to “ON” starts up the camera recorder in the Camera mode to enable shooting.
- 4 **Adjust the angle of the LCD monitor and viewfinder.**
- 5 **Set [System], [Format], [Resolution], [Frame Rate] and [Bit Rate] in [System] → [Record Set] → [Record Format].**
  - You can select the definition of the recorded videos, file format for recording/playback, and the video recording format on this camera recorder.
  - Press the [MENU/THUMB] button to display the menu screen on the LCD monitor and viewfinder.

## Shooting

### 1 Configure the video and audio input settings.

You have to configure video settings such as brightness adjustment (iris, gain, shutter) and white balance adjustment in order to start shooting. You also have to adjust the audio input settings and audio recording level for audio recording.

- Adjusting the Brightness
- Adjusting the White Balance
- Adjusting Audio Input Settings and Recording Level

### 2 Press the [REC] button to start recording to the recording media

The tally lamp lights up in red during recording.

- Zoom Operation
- Adjusting the Focus

Memo :

- If both SD card slots A and B are loaded with recordable SD cards in the factory default state, pressing the [REC] button starts recording only to the media in the selected slot. Configuring [System] → [Record Set] → [Slot Mode] to “Dual” enables recording to be performed simultaneously to the SD cards in both slots A and B.
- The tally lamp can be turned off in [System] → [Tally Lamp].

### 3 Check the most recently captured images.

- Press the user button that is assigned with the Clip Review function. Doing so activates the function and plays back the most recently captured images on the LCD monitor and viewfinder screen.
- After playback, the camera recorder returns to standby mode (STBY).

# Miscellaneous Functions for Shooting and Recording Methods

This camera recorder is equipped with various functions for shooting.

The functions described here are the typical functions of the camera recorder.

## Miscellaneous Functions for Shooting

- **Assignment of user buttons:**  
You can assign functions to the buttons and use them as user buttons.  
Functions can be assigned to the buttons according to the usability.
- **Focus Assist:**  
The focused area is displayed in color to allow easy and accurate focusing.
- **Expanded focus:**  
Magnifies the preferred area to enable precise focus to be established easily.
- **Zebra pattern:**  
Diagonal lines (zebra pattern) are displayed only at the area with the specified luminance levels.
- **Marker:**  
Displays the marker and safety zone when determining the angle of view for the image according to the shooting purpose.

## Recording Methods

### ① Recording using both slots A and B

- **Continuous recording (Series Rec):**  
Enables seamless long hour continuous recordings over the slots.
- **Record simultaneously at the same definition (Dual Rec):**  
Allows you to create two clips of the same content at the same time only on this camera recorder.
- **Backup Rec:**  
Allows you to record only the preferred scenes to one slot using the record and stop operations while the other slot is continuously recording.

### ② Special recording

- \* Special recording can be specified in conjunction with ① under given conditions.
- **Pre Rec:**  
Enables recording to go back to the specified duration in seconds of the video and audio before the actual recording start time. This allows you to record a complete event without missing the initial scenes even if you start the recording late.
- **Clip Continuous Rec:**  
Allows you to consolidate several rounds of “startstop recording” into one clip. You can consolidate the clips while recording when shooting on-and-off and shooting several scenes.
- **Frame Rec:**  
Records as a single clip only in the specified frame rate until the recording is stopped. Useful for shooting clay animation.
- **Interval Rec:**  
Records and pauses repeatedly at the specified time interval and frame rate, and records as a single clip until the recording is stopped. Useful for observation recording.

### ③ Other recordings

- **Clip cutter trig:**  
You can split the clips freely without having to stop recording during shooting.

# Playing Recorded Clips

To play back clips recorded in a recording media, switch to the Media mode.

Press and hold the [MODE] selection button in the Camera mode to enter the Media mode. A thumbnail screen of the clips recorded on the recording media is displayed.

You can play back the selected clip on the thumbnail screen.

Memo : \_\_\_\_\_

- When a recording media without any clips is inserted, "No Clips" is displayed.

Use the operation buttons on the side control panel or front side of the camera recorder to operate the thumbnail screen.

## Playing back

Use the operation buttons on the side control panel of the camera recorder to play back.

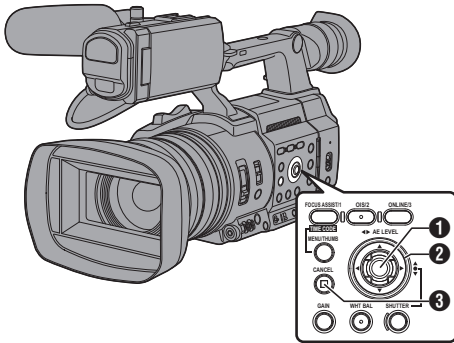

- 1 Set Button (●)**
  - Plays back/pauses the clip pointed by the cursor.
  - You can press the cross-shaped button (◀▶) to perform frame-by-frame forward playback during pause mode.
- 2 Cross-shaped Button (▲▼◀▶)**
  - [▲/▼] Button:  
Skips in the reverse or forward direction.
  - [◀▶] Button:
    - During Playback:  
Fast forwards in the reverse or forward direction.
    - While paused:  
Frame-by-frame playback in the reverse or forward direction.
- 3 [CANCEL] Button**  
Stops playback.

- 1 In the thumbnail screen, move the cursor to the clip to be played back.**

Move the cursor to the clip to be played back using the cross-shaped button (▲▼◀▶).

- 2 Press the Set button (●).**

Playback of the selected clip starts.

## Audio Output during Playback

- You can confirm the playback sound from the monitor speaker, or the headphone connected to the [Φ] terminal. When a headphone is connected to the [Φ] terminal, sound cannot be output from the monitor speaker.
- Adjust the volume of the monitor speaker and headphone using the [MONITOR +/-] volume adjustment button on the LCD monitor section of the camera recorder.

## Displaying Information during Shooting

During playback, pressing the [DISPLAY] button shows the display screen. Pressing the [ONLINE/3] button during shooting switches the display information between camera information display, GPS display and turning off the display.

# Functions of Network Connection

The network feature comprises web-browser-based functions using devices such as a smartphone, tablet terminal, or PC, as well as FTP and live streaming functions that run via thumbnail screens and menu operation.

Memo : \_\_\_\_\_

- When [System] → [Record Set] → [Record Format] → [System] is set to “High-Speed”, only “Planning Metadata” can be used for the [LAN] terminal connection.

## Connecting to the Network

- [LAN] Terminal
- Built-in Wireless LAN **550**
- Connect the following adapters to the [HOST] terminal (USB)
  - Wireless LAN adapter
  - Ethernet adapter
  - Cellular adapter

## List of Functions

### Importing Metadata

You can download a metadata settings file (XML format) from the FTP server and store metadata in the camera recorder.

### Uploading Recorded Clips

Clips recorded to a recording media can be uploaded to a preconfigured FTP server.

Memo : \_\_\_\_\_

- Uploading can also be performed via a web browser.

## Editing Metadata

- Planning Metadata  
You can access the page for editing the camera recorder’s metadata via a web browser on devices such as a smartphone, tablet terminal, or PC, and edit the metadata that is to be applied to clips to be recorded.
- Clip Metadata  
You can access the page for editing the metadata via a web browser on devices such as a smartphone, tablet terminal, or PC, and display or rewrite the metadata that is recorded to a clip.

## View Remote

You can access via a web browser on devices such as a smartphone, tablet terminal, or PC to check the live image or remotely control the camera.

## Camera Control

You can access via a web browser on devices such as a smartphone, tablet terminal, or PC to remotely control the camera.

## Live streaming

By combining with the decoder or PC application that supports live streaming, you can perform audio and video streaming via the network.

Memo : \_\_\_\_\_

- This feature is available when [System] is configured to “HD” or “SD”.

## Broadcast Overlay **550** **SPC**

Texts, images and watermark can be overlaid onto recorded video and live stream video. In addition, changes such as changing the image are possible with the SDP Generator app.

## Scoreboard Overlay **SPC**

A scoreboard can be overlaid onto a recorded or live streaming video. In addition, changes such as changing the image are possible with the “SDP Generator” app.

## Sports Coaching **SPC**

This camera recorder supports the tagging feature, which enables information such as the camera angle and actions of an athlete to be recorded in real time as metadata during sports photography or videography.

# Preparing Network Connection

## Operating Environment

Operation has been verified for the following environments.

### Computer

- OS: Windows 7  
Web browser: Internet Explorer 11
- OS: Windows 10  
Web browser: Chrome
- OS: macOS 10.14  
Web browser: Safari 12

### Smartphone/Tablet Terminal

- OS: iOS11 (iPhone X/iPad Pro)  
Web browser: Safari 11
- OS: Android 8  
Web browser: Chrome

## Camera Setup for Network Connection

### 1 Connect using the corresponding method of connection

- [LAN] Terminal  
Connect a PC to this camera recorder directly using a cross-over cable or via devices such as an Ethernet hub using a LAN cable.
- Built-in Wireless LAN **550**  
Attach the wireless LAN antenna if it is not mounted.
- Connect the following adapters to the [HOST] terminal (USB)
  - Wireless LAN adapter
  - Ethernet adapter
  - Cellular adapter

Memo : \_\_\_\_\_

- Only a network connection adapter can be connected to the [HOST] terminal (USB).
  - Connect or disconnect an adapter only after you have turned off the power of the camera recorder.
  - You can find the latest information on the compatible adapters at the product page of our website.
  - Two types of network coverage (WAN and LAN) are available for each application.
-

# Connecting to the Network

## Connecting to the Network

### 1 Select the interface in the [Wizard].

- In [Network] → [Connection Setup] → [Wizard], select “LAN”, “USB” or [Built-in Wireless LAN] 550.
- When “USB” is selected, the adapter that is connected to the [HOST] terminal (USB) is recognized and displayed.

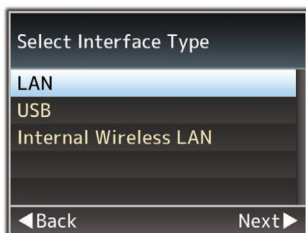

### 2 Configure the settings according to the selected interface.

- Wired LAN connection (“LAN” or “USB”-“Ethernet”)

Configure the settings as follows according to the screen.

- IP address setting (DHCP or manual)
- IP Address
- Subnet mask
- Default gateway
- DNS Server

Memo : \_\_\_\_\_

- When an address is manually assigned in a NAT environment, it is also necessary to set the default gateway correctly besides conversion of the address at the router’s end in order to perform operations such as access to the Internet from an external network via the router.

- Wireless LAN connection (“Built-in Wireless LAN” 550 or “USB”-“Wireless LAN”)
- When “Connect with Access Point” or “P2P”-“WPS” is selected on the [Select Connection Type] screen.

Configure the settings as follows according to the screen.

- Mode of connection
- Configuration method

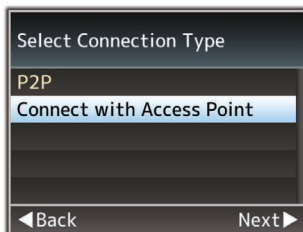

- When “P2P”-“Manual” is selected on the [Select Connection Type] screen. Configure the settings as follows according to the screen.
- Mode of connection
- Configuration method

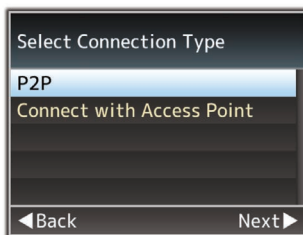

- \* For “P2P”-“Manual” connections, it is necessary to configure the [Passphrase] according to the steps below after the above settings are configured.

- ① Set the camera recorder to the Camera mode, and display [Connection Setup] (status screen).
  - Press the [STATUS] button on the camera recorder to display the status screen. Press the cross-shaped button (◀▶) to display [Connection Setup].
  - Check to ensure that the [SSID] and [Passphrase] that you have set in the wizard are displayed.
- ② Select [SSID] from the list of access points (smartphone, tablet terminal, PC, etc.), and enter [Passphrase].

# Connecting from a Web Browser

- Display the list of access points in the wireless connection settings of the smartphone, tablet terminal, or PC, and select “[HC550-\*\*\*\*]550” and “[HC500-\*\*\*\*]500”. (\*\*\*\* are numbers that vary with the device used.)
- After the password confirmation screen appears, enter the [Passphrase] displayed on the [Connection Setup] screen.



- Cellular adapter connection (“USB”-“Cellular”)

Configure the settings as follows according to the screen.

- Connection phone number
- Username
- Password

Caution :

- You can access the web functions via a web browser on devices such as a smartphone, tablet terminal, or PC only in a LAN environment.
- Note that you may have to pay very high bills in the case of pay-per-use contracts. Fixed price contract is recommended if you are using the network function.
- Note that the use of improper settings may result in expensive bills from the phone service provider. Make sure that the setting is correct.
- To avoid expensive bills due to the roaming connection, you are recommended to use this function by disabling the roaming contract.
- There may be communication even when you are not using the network function. Remove the cellular adapter when the function is not in use.

### 3 Setting is complete.

After setting is complete, you can access the camera recorder via a web browser.

You can access the web functions of this camera recorder via a web browser on devices such as a smartphone, tablet terminal, or PC. Make the necessary preparations for connection in advance.

#### 1 Set the camera recorder to the Camera mode, and display [Connection Setup] (status screen).

- Press the [STATUS] button on the camera recorder to display the status screen. Press the cross-shaped button (◀▶) to display the [Connection Setup] screen.
- Check the displayed [IP Address].

#### 2 Start up the web browser on the terminal you wish to connect to the camera recorder, and enter the [IP Address] in the address field.

(Example: 192.168.0.10)

If “192.168.0.10” is displayed in [IP Address], enter “http://192.168.0.10”.



#### 3 Enter the user name and password.

Enter the user name and the password on the login screen to display the main page of the camera.

- Check the [Web Username] and [Web Password] in the [Network] screen (status screen).

Memo :

- The user name and password can be changed in [Network] ⇒ [Web] ⇒ [Username] and [Password].



# Menu Screen Hierarchical Chart

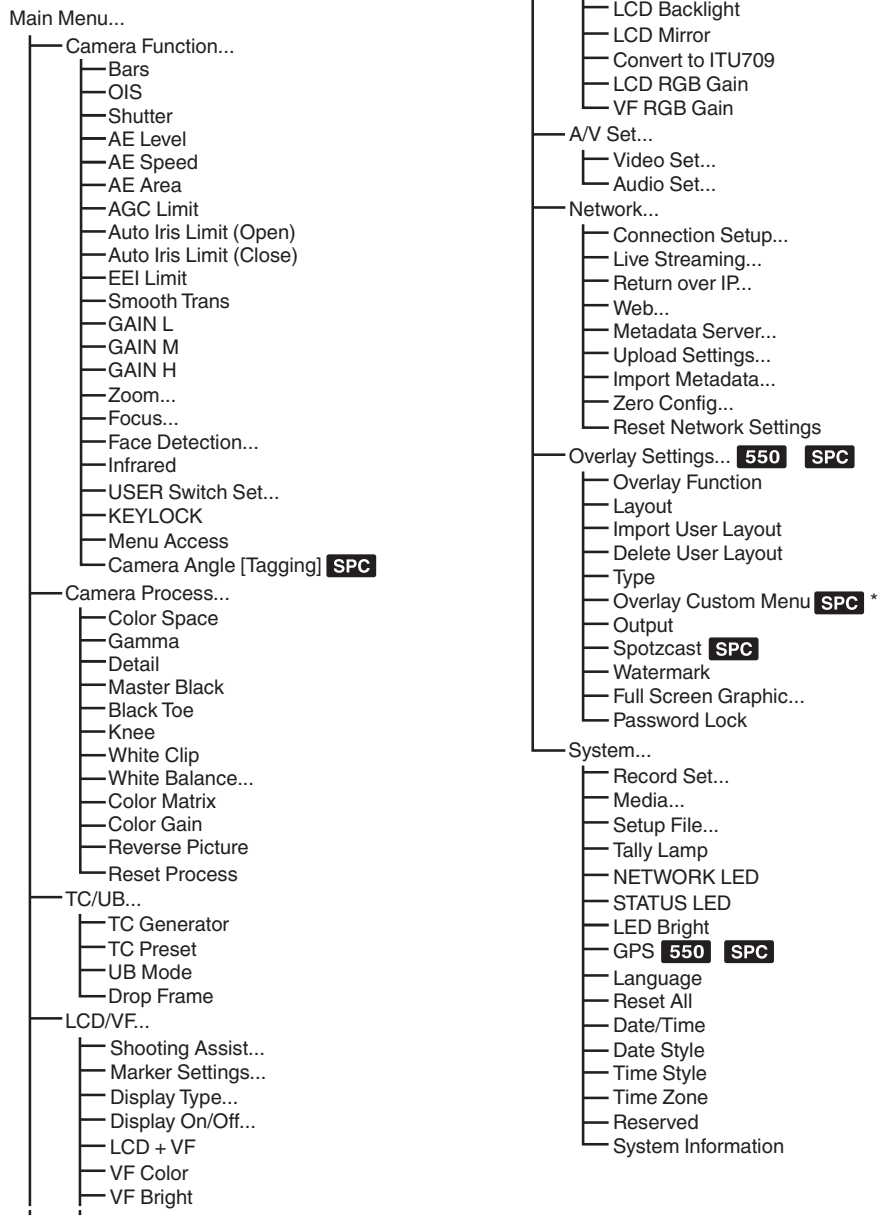

Only menu items that can be set using this camera recorder are introduced here.  
For details on each item, please refer to the "Mobile User Guide".

\* The display of the Overlay Custom Menu changes according to the imported data.

# Basic Operations in Menu Screen

- Pressing the [MENU/THUMB] button displays the menu screen on the LCD monitor and viewfinder.
- Various settings for shooting and playback can be configured on the menu screen.
- There are two types of menu screens - [Main Menu] and [Favorites Menu].
- [Main Menu] contains all the setting items of the camera recorder, classified according to functions and uses, while [Favorites Menu] allows users to customize the menu items freely.
- The operating procedures and main screen displays are the same for both menus.
- The menu screen can also be displayed on external monitors connected to the video signal output terminal.

## Operation Buttons

To operate the menu, use the cross-shaped buttons on the side operation panel of the camera recorder or the cross-shaped buttons at the front of the camera or at the bottom of the lens.

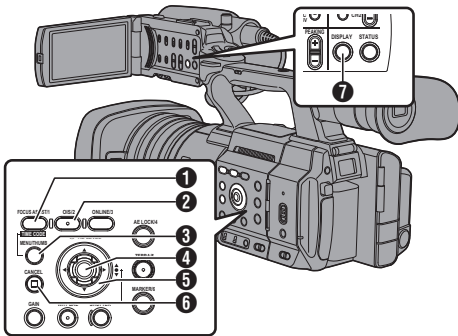

- 1** [FOCUS ASSIST/1] Button  
Adds the selected menu or submenu item to the [Favorites Menu].
- 2** [OIS/2] Button  
Resets settings in the [TC Preset] or [UB Preset] setting screen.
- 3** [MENU/THUMB] Button
  - Displays the menu screen. The [Main Menu] screen is displayed by default.
  - During normal usage, [Main Menu] is displayed if the previous menu operation ended at [Main Menu], and [Favorites Menu] if the previous menu operation ended at [Favorites Menu].
  - Press this button to close the menu screen during menu display and return to the normal screen.
  - Pressing and holding down the button while the menu is displayed switches the [Main Menu] screen to the [Favorites Menu] or vice versa.
- 4** Set Button (●)  
Sets the values and items.
- 5** Cross-shaped Button (▲▼◀▶)
  - ▲ : Moves the cursor upward.
  - ▼ : Moves the cursor downward.
  - ◀ : Moves back to the previous item.
  - ▶ : Moves forward to the next item.
- 6** [CANCEL] Button  
Cancels settings and returns to the previous screen.
- 7** [DISPLAY] Button  
Switches between the [Main Menu] and [Favorites Menu] screens.

# Display Screen in Camera Mode

When the display setting for [LCD/VF] → [Display On/Off] is set to “Off”, the corresponding display is hidden. However, the display may appear during event display or warning display.

Memo : \_\_\_\_\_

- When the display setting for [LCD/VF] → [Display On/Off] is set to “On”, the display screen appears only in the following cases if it has been turned off.
  - Approximately 3 seconds when changes are being made
  - During event display or warning display

## Display Screen

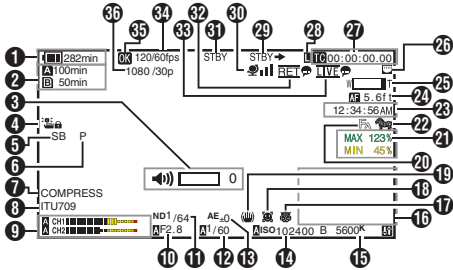

- 1 Voltage/Battery Power**  
Displays the current status of the power supply in use.

Memo : \_\_\_\_\_

- Even when the display screen is turned off and [LCD/VF] → [Display On/Off] → [Battery] is set to “Off”, this will be displayed when there is a warning.

- 2 Remaining Space on Media**  
Displays the remaining recording time for the recording media in slot A and slot B separately.

- A B** : Currently selected slot. (White card)
- EXT**
- A** : Write-protect switch of SD card is set.
- A!INVALID** : When a recording media writing/reading error has occurred, or when the recording media is irreparable.
- A!FORMAT** : Recording media requires formatting.
- A!RESTORE** : Recording media requires repair.

- A!INCORRECT** :
    - Recording media is not supported.
    - When an SD card lower than Class 10 is inserted while in the XHQ mode.
  - A!REC INH** :
    - When attempting to record more than 4 GB while an SD card that does not support recording of more than 4 GB is inserted.
- The following icons are displayed during FTP upload.

Icon	Status
	[Auto Upload] is configured to “On” and in the standby state. “A” is displayed at the top left corner of the icon while in the Auto FTP mode.
	Auto FTP transfer is in progress. Three images are alternately displayed, and the arrows become animated.
	FTP transfer is in progress. Three images are alternately displayed, and the arrows become animated. In this case, instead of the remaining recordable time on the recording media, an estimated value of the remaining transfer time is displayed.
	Error has occurred during FTP transfer. (Yellow)

- Memo : \_\_\_\_\_
- The displayed time is an estimate.
  - Even when the display screen is hidden and [LCD/VF] → [Display On/Off] → [Media Remain] is set to “Off”, this will be displayed when there is a warning.

- 3 Volume Operation Indicator**  
Displayed when there are changes made to the volume of the headphone (0 to 15), the values of LCD BRIGHT (☼) or PEAKING (☺) (-10 to +10).

- 4 Operation lock**  
The icon appears during operation lock.

- Memo : \_\_\_\_\_
- The icon appears for 3 seconds after operation lock is turned off.



- 15** White Balance Mode  
Displays the current white balance mode.  
(\*\*\*\*K indicates color temperature)
- A \*\*\*\*K : When the [WHT BAL B/A/PRESET] switch is set to "A" in the Manual White Balance mode.
- B \*\*\*\*K : When the [WHT BAL B/A/PRESET] switch is set to "B" in the Manual White Balance mode.
- P \*\*\*\*K : When the [WHT BAL B/A/PRESET] switch is set to "PRESET" in the Manual White Balance mode.
- A** FAW : During Full Auto White Balance mode.
- L** FAW : While in the Full Auto White Balance mode, and [AE Lock] is set for "FAW" or "AE/FAW" during lock operation.

Memo : \_\_\_\_\_

- When [Preset Paint], [AWB Paint] or [FAW Paint] is set to a setting other than the default value, a **L** icon is displayed to the right of the color temperature.

- 16** Expanded Focus/Histogram  
Displayed upon pressing the user button that is assigned with "Expanded Focus" and "Histogram".

Memo : \_\_\_\_\_

- Display switches in the order of "Expanded Focus" > "Histogram".

- 17** Infrared Recording  
"IR" is displayed when the infrared recording is ON.

- 18** Face Detect  
Displayed when Face Detect is ON.
- F** : When [Face Detect] is set to "ON"
- F ONLY** : When [Face Only AF] is configured to "ON" while [Face Detect] is "ON"

- 19** Image Stabilizer Mark  
Displayed when the image stabilizer is ON.
- (U)** : When [Level] of [OIS] is set to "Normal".
- (UU)** : When [Level] of [OIS] is set to "High".

Memo : \_\_\_\_\_

- When Image Stabilizer is configured to "OFF", **(U)** is displayed for 3 seconds.

- 20** Focus Assist
- "FA" is displayed when auto focus is activated.
  - When ACCU-Focus is enabled, "ACCU FA" blinks for about 10 seconds while Focus Assist starts up, after which the "FA" indicator lights up.
  - If recording starts while [ACCU-Focus] is active, [ACCU-Focus] will be forcibly deactivated.

- 21** Luminance Information  
Displayed when the Spot Meter function is activated.
- MAX : Maximum luminance  
MIN : Minimum luminance

- 22** Zebra pattern  
During zebra pattern display, **(Z)** (zebra icon) is displayed on the display screen in Camera mode.

- 23** Time Display  
Displays the current time.

Memo : \_\_\_\_\_

- The date/time display style can be configured in [System] → [Date/Time].
- When [System] → [Record Set] → [Time Stamp] is set to "On", this item is not displayed.

- 24** Focus Display  
Displays the focus state and the approximate distance to the subject in focus.
- MF** : Manual focus  
**AF** : Autofocus  
**L** : Autofocus lock  
**(□)** : [AF Area]-"Wide"  
**(□□)** : [AF Area]-"Multi"

Memo : \_\_\_\_\_

- The displayed unit of measurement (feet or meter) can be configured in [LCD/VF] → [Display Type] → [Focus].

**25** Zoom Display

- Displays the zoom position. (Zoom bar or value)

Dynamic Zoom Off:



Dynamic Zoom On:



- The zoom bar will only be displayed for 3 seconds after the zoom operation is activated.
- The value will always be displayed.
- When [Digital Extender] is configured to “On”, “2x” is displayed to the right of the zoom display.

Memo : \_\_\_\_\_

- The mode of display (value or bar) can be configured in [LCD/VF] → [Display Type] → [Zoom].

**26** Network Connection Icon

The network connection status is displayed.

Icon	Status
	Wireless LAN connection from the host terminal (USB) is established
	Wired LAN connection from the host terminal (USB) is established
	Cellular adapter connection from the host terminal (USB) is established
	When a USB adapter different from the connection settings is detected
	Built-in wireless LAN connection is established
	LAN terminal connection is established
(No display)	<ul style="list-style-type: none"> <li>• When an unusable USB adapter is detected</li> <li>• When the LAN cable is not connected</li> </ul>

Memo : \_\_\_\_\_

- Yellow display indicates preparation for connection in progress.

**27** Time Code (TC)/User's Bit (UB) Display

- Displays the time code (hour: minute: second: frame) or user's bit data.
- Example of time code display: Display Screen



- \* Colon (: ) denotes non-drop frames and dot (.) denotes drop frames.

- Example of user's bit display: Display Screen



Memo : \_\_\_\_\_

- Use [LCD/VF] → [Display Type] → [TC/UB] to toggle between the time code display and user's bit display.

**28** Time Code Lock Indicator

When the built-in time code generator is synchronized to the external time code data input during the synchronization of time code with another camera recorder, lights up.

**29** IFB/RET Mark

Displays the status of the IFB or Return over IP.

Icon	Status
	During audio feed only
	When an error occurs during audio feed only
	During video+audio feed
	When an error occurs during video+audio feed











- 30** SDI/HDMI Record Trigger  
 STBY → : When [A/V Set] → [Video Set] → [SDI OUT] → [Rec Trigger] is set to “Type-A” or “Type-B”, or [HDMI OUT] → [Rec Trigger] is set to “On” and recording is stopped  
 REC → : When [A/V Set] → [Video Set] → [SDI OUT] → [Rec Trigger] is set to “Type-A” or “Type-B”, or [HDMI OUT] → [Rec Trigger] is set to “On” and recording is in progress

- 31** GPS Mark **550** SPC  
 When [System] → [GPS] is set to “On”, the signal reception status is displayed.

Memo : \_\_\_\_\_



- The display changes according to the signal reception sensitivity. If signals cannot be received, the  mark appears in yellow regardless of the [LCD/VF] → [Display On/Off] → [GPS] setting.
- This item is not displayed when [GPS] is set to “Off”.

**32** Media Status

- : A card is not detected in the selected slot, and [Tally Lamp] is also not set to “External”
- STBY : Recording standby
- REC : Recording
- REVIEW : Clip Review
- STBY  : Pre Rec recording standby
- REC  : Pre Rec recording
- STBY  : Clip Continuous Rec recording standby
- REC  : Clip Continuous Rec recording (displayed in yellow)
- STBY  : Interval Rec recording standby
- STBY  : Interval recording pause (displayed in red)
- REC  : Interval Rec recording
- STBY  : Frame Rec recording standby
- REC  : Frame Rec recording
- STBY  : Frame Rec recording pause (displayed in yellow)

- STOP : Unable to record to the card in the slot
- P.OFF : Power OFF
-  : During clip cutter recording (displayed for 3 seconds)
- CALL : Receiving call signals from an external device, such as a remote control unit
- PGM : Receiving program signals from an external device, such as a remote control unit
- PVW : Receiving preview signals from an external device, such as a remote control unit

- 33** Live streaming mark  
 When [Network] → [Live Streaming] → [Live Streaming] is set to “On”, the distribution status is displayed.

Icon	Status
 (Red)	Distribution in progress (good connection quality)
 (Red)	Distribution in progress (poor connection quality)
 (Yellow)	Waiting for connection (RTSP/RTP only), connection failed

- 34** High-Speed Frame Rate  
 • When [System] → [Record Set] → [Record Format] → [System] is configured to “High-Speed”, the setting value for [A]Frame Rate] is displayed.
- 35** OK Mark  
 Displayed when OK mark has been appended.
- 36** Recording Format  
 Displays the recording format.

Memo : \_\_\_\_\_

- The resolution, frame rate and bit rate can be viewed on the status screen.

# Display Screen in Media Mode

When the display setting for [LCD/VF] → [Display On/Off] is set to "Off", the corresponding display is hidden.

Memo : \_\_\_\_\_

- Display on the information display area can be toggled using the [ONLINE/3] button.
- When the display setting for [LCD/VF] → [Display On/Off] is set to "On", the display screen appears only in the following cases if it has been turned off.
  - During event display or warning display

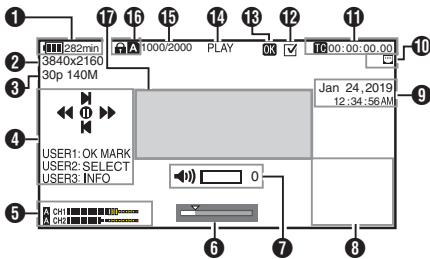

- 1 Voltage/Battery Power**  
Displays the current status of the power supply in use.

Memo : \_\_\_\_\_

- Even when the display screen is turned off and [LCD/VF] → [Display On/Off] → [Battery] is set to "Off", this will be displayed when there is a warning.

- 2 Resolution**  
Displays the video image resolution.
- 3 Frame Rate/Bit Rate**  
Displays the frame rate and bit rate in pairs.
- 4 Operation Guide**  
Displays a guide for the current operation buttons.
- 5 Audio Level Meter**
  - Displays the audio levels for CH-1 to CH-2.



- The display appears when the volume (0 to 15) of the headphone or speaker changes.

- 6 Position Bar**  
Displays the current position in the video. During trimming, the position bar appears in green, and icons for the in and out points are displayed.

- ▼ : Current position of the video
- ▲ : Position to start trimming (In point)
- ▲ : Position to end trimming (Out point)

- 7 Volume Operation Indicator**  
Displayed when there are changes made to the volume of the headphone, speaker (0 to 15), the values of LCD BRIGHT (☼) or PEAKING (☉) (-10 to +10).

- 8 Information Display**  
Use the [ONLINE/3] button to switch between camera information display, GPS display and turning off the display.

- The GPS display displays information on the recording location of the video being played back only when GPS information has been recorded.
- Camera information display displays only information of Gain, Iris, Shutter and White Balance that have been recorded.

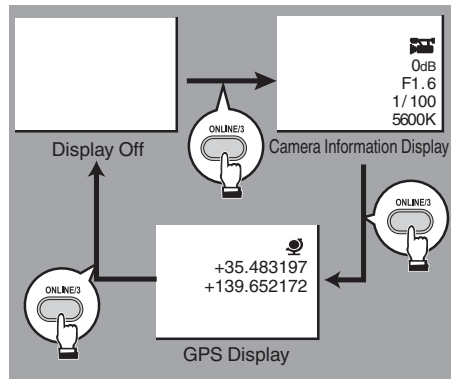

Memo : \_\_\_\_\_

- Trimming information is displayed while trimming is in progress. In this case, pressing the [ONLINE/3] button does not switch the display.
- The information display area is not subject to the display settings of the items in [LCD/VF] → [Display On/Off].









- 9 Date/Time Display  
Displays the date/time that is recorded on the currently played recording media.

Memo : \_\_\_\_\_

- The date/time display style can be specified in [System] → [Date Style]/[Time Style].

- 10 Network Connection Icon  
The network connection status is displayed.

Icon	Status
	Wireless LAN connection from the host terminal (USB) is established
	Wired LAN connection from the host terminal (USB) is established
	Cellular adapter connection from the host terminal (USB) is established
	When a USB adapter different from the connection settings is detected
	Built-in wireless LAN connection is established 550
	LAN terminal connection is established
(No display)	<ul style="list-style-type: none"> <li>• When an unusable USB adapter is detected</li> <li>• When the LAN cable is not connected</li> </ul>

Memo : \_\_\_\_\_

- The icon appears blinking when the camera recorder is starting up, and is displayed in yellow while getting ready to connect.

- 11 Time Code (TC)/User's Bit (UB) Display
- Displays the time code (hour: minute: second: frame) or user's bit data recorded in the recording media being played back.
  - Example of time code display:

TC00:00:00:00  
\*

- \* Colon (: ) denotes non-drop frames and dot (.) denotes drop frames.

- Example of user's bit display:

UBFF EE DD 20

Memo : \_\_\_\_\_

- Use [LCD/VF] → [Display Type] → [TC/UB] to toggle between the time code display and user's bit display.

- 12 Check Mark  
Displayed when the currently played clip is selected.
- 13 OK Mark  
Displayed when OK mark has been appended.

- 14 Media Status

PLAY : Playing  
 STILL : Still picture playback mode  
 FWD \* : High-speed playback in the forward direction (\* playback speed: 5x, 15x, 60x, or 360x)  
 REV \* : High-speed playback in the reverse direction (\* reverse playback speed: 5x, 15x, 60x, or 360x)  
 STOP : Stop mode  
 P.OFF : Power OFF

- 15 Clip Information  
Displays current clip number/total number of clips.

- 16 Media
- Displays the media slot of the currently played clip.
  -  appears when the write-protect switch of the SD card is set.

- 17 Event/Warning Display Area  
Displays error messages.

# Status Screen

- This screen allows you to check the current settings.
- To display the status screen, press the [STATUS] button in the normal screen.
- Press the [STATUS] button to switch to the status screen.
- Press the [MENU/THUMB] button at each status screen (other than the [Camera] screen) to enter the setting screen.
- Use the cross-shaped button (◀▶) to switch between the screens.

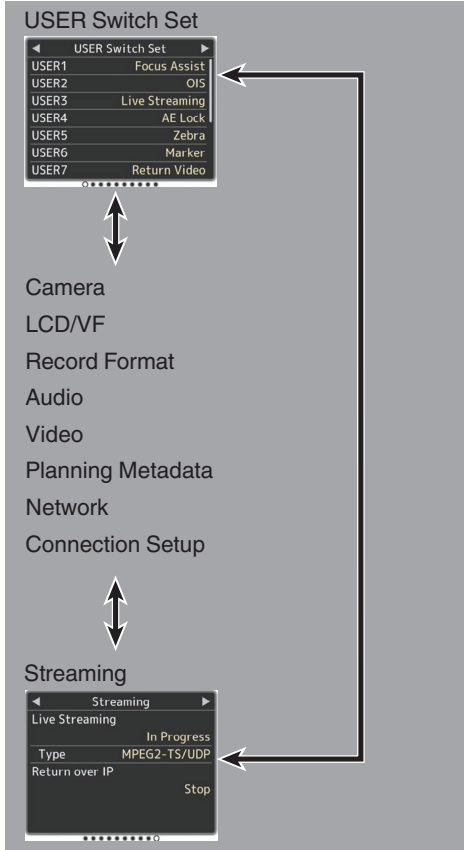

\* These are screen examples. The contents displayed are different depending on the model and settings.

# Troubleshooting

Symptom	Action
Power does not turn on.	<ul style="list-style-type: none"> <li>• Is the AC adapter properly connected?</li> <li>• Is the battery charged?</li> <li>• Is the power turned on immediately after it is turned off? Make sure to wait for an interval of at least 5 seconds before turning on the power again.</li> </ul>
Unable to start recording.	<ul style="list-style-type: none"> <li>• Is the record trigger button/lock switch on the handle turned on?</li> <li>• Is the write-protect switch of the SD card turned on? Make sure that the write-protect switch is turned off.</li> <li>• Is the camera recorder set to the Camera mode? Use the [MODE] selection button to switch to the Camera mode.</li> <li>• Is the SD card inserted compatible with the recording format?</li> </ul>
Camera image is not output on the LCD monitor and viewfinder screen.	<ul style="list-style-type: none"> <li>• Is the camera recorder set to the Camera mode? Use the [MODE] selection button to switch to the Camera mode.</li> <li>• The LCD monitor and viewfinder screens cannot be displayed at the same time. To display the viewfinder screen, close the LCD monitor or press and hold the [DISPLAY] button.</li> </ul>
Playback does not start after selecting a clip thumbnail and pressing the Set button (●).	<ul style="list-style-type: none"> <li>• Is the selected clip a playable clip? Playback is not possible if the clip has a different video format setting.</li> </ul>
Images on the LCD monitor and viewfinder screen appear dark or blurred.	<ul style="list-style-type: none"> <li>• Readjust the brightness of the LCD monitor and viewfinder.</li> <li>• Is the [ND FILTER] switch set to "1/64"?</li> <li>• Is the iris closed?</li> <li>• Is the shutter speed setting too high?</li> <li>• Is the peaking level too low? Use the [PEAKING +/-] button to adjust the contour for the LCD monitor and the viewfinder screen.</li> </ul>
The [CH1/CH2] recording level adjustment knob does not work.	<ul style="list-style-type: none"> <li>• Is the [CH1/CH2 AUTO/MANUAL] switch set to "AUTO"?</li> <li>• Is the [FULL AUTO] switch set to "ON"? Is the [FULL AUTO] switch set to "ON", and [A/V Set] → [Audio Set] → [FULL AUTO] set to "Auto"?</li> </ul>
Microphone audio cannot be heard through the headphone.	<ul style="list-style-type: none"> <li>• Is the audio setting configured to "IFB/RET Only"? Set [A/V Set] → [Audio Set] → [IFB/RET Monitor] → [CH1]/[CH2] to "Off".</li> </ul>
SD card cannot be initialized (formatted).	<ul style="list-style-type: none"> <li>• Is the write-protect switch of the SD card turned on? Make sure that the write-protect switch is turned off.</li> </ul>
Battery alarm appears even after loading a charged battery.	<ul style="list-style-type: none"> <li>• Is the battery too old?</li> </ul>
The time code and user's bit are not displayed.	<ul style="list-style-type: none"> <li>• Even in Camera mode or Media mode, the time code and user's bit may not be displayed depending to the type of display.</li> <li>• Is [LCD/VF] → [Display On/Off] → [TC/UB] set to "Off"? To display the date and time, set it to "On".</li> </ul>

Symptom	Action
The time is not displayed.	<ul style="list-style-type: none"> <li>The time is only displayed on the display screen in the Camera mode (during shooting).</li> <li>Is [System] → [Record Set] → [Time Stamp] set to “On”? To display the date and time, set it to “Off”.</li> </ul>
The actual recording time is shorter than the estimated time.	<ul style="list-style-type: none"> <li>The recordable time may be shorter depending on the shooting conditions or the subject.</li> </ul>
The two camera recorders are not synchronized even though the time codes have been synchronized. (L on the Slave device is not displayed.)	<ul style="list-style-type: none"> <li>Is the [TC IN/OUT] switch correctly set?</li> <li>Set [System] → [Record Set] → [Record Format] → [Frame Rate] such that the two camera recorders have the same frame rate.</li> </ul>
Cannot connect to wireless LAN.	<ul style="list-style-type: none"> <li>Check the mode of connection and method of setting ([SSID] and [Passphrase] in cases other than WPS).</li> <li>Even if the Passphrase is wrong, “Completed the Setup Wizard. Please Input the Passphrase into Your Device.” may appear at the browser setting depending on the type of encryption. Adjust [Passphrase] again.</li> </ul>
The View Remote screen turns black. The screen flickers. The screen freezes. Cannot perform remote operation.	<ul style="list-style-type: none"> <li>The network path is congested. Wait a while before refreshing (reloading) the web browser.</li> <li>Clear the cache in your Web browser.</li> </ul>
The clips cannot be uploaded to the FTP server.	<ul style="list-style-type: none"> <li>Adjust the [Clip Server] settings.</li> <li>If a file size limit is set in the FTP server, set the size limit such that it is larger than the maximum size of the recorded clip.</li> </ul>
The wireless LAN is disconnected.	<ul style="list-style-type: none"> <li>The wireless LAN may be disconnected depending on the environment. Change the usage environment.</li> <li>Connect via wired LAN.</li> </ul>
The images and audio sound during live streaming are choppy.	<ul style="list-style-type: none"> <li>Depending on the connection method to the network and connection environment, streaming may not be possible with the encoding bit rate specified. Please reduce the encoding bit rate.</li> </ul>
GPS signal cannot be received. 550 SPC	<ul style="list-style-type: none"> <li>Signal reception from GPS satellites may be affected by buildings or trees. Perform positioning preferably at an unobstructed location with a clear view.</li> <li>Radio wave reception may be affected by weather conditions such as on a cloudy or rainy day.</li> </ul>
The position is not accurate. 550 SPC	<ul style="list-style-type: none"> <li>The precision error may be up to hundreds of meters if the GPS signal is weak or reflected off surrounding buildings.</li> </ul>

# Precautions for Proper Use

## Storage and Usage Locations

- Allowable ambient temperature and humidity  
Be sure to use this unit within the allowable temperature range of 0 °C to 40 °C (32 °F to 104°F) and a relative humidity of 30 % to 80 %. Using this unit at a temperature or humidity outside the allowable ranges could result not only in malfunction but also serious impact on the CMOS elements as small white spots may be generated. Please exercise care during use.
- Strong electromagnetic waves or magnetism  
Noise may appear in the picture or audio and/or the colors may be incorrect if this unit is used near a radio or television transmitting antenna, in places where strong magnetic fields are generated by transformers, motors, etc., or near devices emitting radio waves, such as transceivers or cellular phones.
- Use of wireless microphone near this unit  
When a wireless microphone or wireless microphone tuner is used near this unit during recording, the tuner could pick up noise.
- Avoid using or placing this unit in the following places.
  - Places subject to extreme heat or cold
  - Places with excessive dirt or dust
  - Places with high humidity or moisture
  - Places subject to smoke or vapor such as near a cooking stove
  - Places subject to strong vibrations or unstable surfaces
  - In a parked car under direct sunlight or near a heater for long hours
- Do not place this unit at places that are subject to radiation or X-rays, or where corrosive gases occur.
- Protect this unit from being splashed with water. (Especially when shooting in the rain)
- Protect this unit from getting wet when shooting on a beach. In addition, salt and sand may adhere to the body. Be sure to clean the unit after use.
- Protect this unit against penetration of dust when using it in a place subject to sandy dust.

## Carrying the Camera

- Do not drop or hit this unit against a hard object when transporting.

## Power Saving

- When this unit is not in use, be sure to set the [POWER ON/OFF] switch to "OFF" in order to reduce power consumption.

## Maintenance

- Turn off the power before performing any maintenance.
- Wipe the external cabinet of the unit with a soft cloth. Do not wipe the body with benzene or thinner. Doing so may cause the surface to melt or turn cloudy. When it is extremely dirty, soak the cloth in a solution of neutral detergent, wipe the body with it, and then use a clean cloth to remove the detergent.

## Rechargeable Battery

- Be sure to use only the specified batteries. We do not guarantee the safety and performance of this device if an unspecified battery is used.
- Store the battery in a cool and dry place when not in use. Do not expose the battery to high temperatures (such as in a car under direct sunlight). Failure to do so not only shortens the battery life but also damages the battery.
- Charge the battery first before using.
- If you are not using the battery for a prolonged period of time, remove and keep the battery at a 30 % to 40 % charge level to prevent deterioration.
- Recharge the battery to a level of 10 % to 20 % once every six months when storing the battery. Storing the battery at a fully discharged state will result in over discharging and inability to charge the battery.
- **ATTENTION:**



The product you have purchased is powered by a rechargeable battery that is recyclable. Please call 1-800-8-BATTERY for information on how to recycle this battery.

## Regular Inspection (Maintenance)

- Under normal environment, dust will accumulate on the camera recorder when it is used over a long period. Dust may enter the camera recorder especially if it is used outdoors. This may affect the image and sound quality of the camera recorder. Check and replace the fan after every 9000 hours (suggested guideline). You can check the usage time of the fan in [System] ➔ [System Information] ➔ [Fan Hour]. If the fan is used for more than 9000 hours without replacement, "Fan Maintenance Required" will be displayed every time you turn on the power.

## SDHC/SDXC Cards

- SDHC/SDXC card is referred to as “SD card” or “recording media” in this manual.
- This camera recorder saves the recorded images and audio sound on the SD card (sold separately) in the card slot.
- If the SD card contains files recorded by devices other than this camera recorder or files that are saved from a PC, the recordable time may be shorter or data may not be properly recorded. In addition, the remaining space on the card may not increase even when files are deleted using a PC.
- For details on the combinations of usable SD card and format setting, refer to [Usable Cards] (P 22).

\* Using cards other than those from Panasonic, TOSHIBA or SanDisk may result in recording failure or data loss.

## Handling of SD Cards

- The status indicator lights up in red when data on the SD card is being accessed.  
Do not remove the SD card during data access (such as recording, playback, or formatting). Do not turn off the power or remove the battery and AC adapter during access either.
- Do not use or store the SD card in a place that is subject to static electricity or electrical noise.
- Do not place the SD card near locations that are exposed to strong magnetic fields or radio waves.
- Inserting the SD card incorrectly may result in damage of this unit or the SD card.
- We are not liable for any accidental loss of data stored on the SD card. Please back up any important data.
- Make use of the SD card within the prescribed conditions of use.  
Do not use it at the following locations.  
Places that are subject to direct sunlight, high humidity or corrosion, places near thermal equipment, sandy or dusty places, or in a car under the sun with the doors and windows closed.
- Do not bend or drop the SD card, or subject it to strong impact or vibration.
- Do not splash the SD card with water.
- Do not dismantle or modify the SD card.
- Do not touch the terminals with your hands or with a metal object.
- Do not allow dust, dirt, water, or foreign objects to adhere to the terminals.
- Do not remove the labels or stick other labels or stickers on the SD cards.

- Do not use pencils or ballpoint pens to write on the SD cards. Always use oil-based pens.
- If you format (initialize) the SD card, all data recorded on the card, including video data and setup files, will be deleted.
- You are recommended to use cards that are formatted (initialized) on this camera recorder.
  - The SD card may be damaged if the camera recorder is not operated correctly. Formatting (Initializing) the SD card may allow it to operate correctly.
  - SD cards that have been formatted (initialized) on other cameras, computers or peripheral equipment may not operate correctly. In this case, format (initialize) the SD card on this camera recorder.
- If you want to wipe out all information by completely erasing the data, we recommend either using commercially available software that is specially designed for that purpose, or by physically destroying the SD card with a hammer, etc. When formatting or erasing data using the camera recorder, only the file administration information is changed. The data is not completely erased from the SD card.
- Some commercially available SD cards may be harder to be removed from this unit. Remove them by hooking onto the groove on the cards.
  - It will be easier to remove the cards after several times.
  - Do not stick any stickers on the cards.



- The SD card may pop out when it is being removed. Be careful not to lose the card.

## Encryption in Network Connection

- Wireless LAN connections make use of an encryption function.  
This encryption is designed for commercially-sold equipment, and it cannot be altered.

## LCD Monitor and Viewfinder

- The LCD monitor and viewfinder screen are manufactured using high-precision technology. Black or bright spots may appear on the LCD monitor and viewfinder screen. This is not a malfunction. These spots will not be recorded.
- If you use this unit continuously for a long period of time, the characters displayed in the viewfinder may temporarily remain on the screen. This phenomenon will not be recorded to the recording media. They will not appear after you turn the power off and then on again.
- If you use this unit in a cold place, the images may appear to lag on the screen, but this is not a malfunction. Retained images are not recorded on the SD card.
- Do not press against the surface with force or subject it to strong impact. Doing so may damage or break the screens.
- Noise may appear in the viewfinder when switching between the live video and playback images.
- Due to the characteristic of the viewfinder display device, colors may appear on the images when you blink your eyes. It does not affect the recorded images, SDI output, or HDMI output.

## GPS **550** **SPC**

- The GPS (Global Positioning System) satellites are managed by the Department of State of the U.S., and its precision may be altered intentionally.
- Perform positioning at an unobstructed location with a clear view that is not indoors or blocked by trees.
- The time needed for obtaining the position information may be longer and variation may also be larger depending on the surrounding environment and time of day.
- This camera recorder uses the WGS 84 World Geodetic System.
- Signal from GPS satellites may be interrupted by communication signal from electronic devices such as mobile phones.
- Make use of it in accordance with the regulations of the country, region or location of use.

## Copyright

- Any recordings made on this camera recorder that are played back for profit or public preview may infringe on the rights of the owner of the recordings.  
Do not use the recordings for purpose other than personal enjoyment without prior consent from the owner. And even for personal enjoyment, you may not be able to record without permission from the owner.

## License Notices

- MPEG LA AVC  
THIS PRODUCT IS LICENSED UNDER THE AVC PATENT PORTFOLIO LICENSE FOR THE PERSONAL USE OF A CONSUMER OR OTHER USES IN WHICH IT DOES NOT RECEIVE REMUNERATION TO  
(i) ENCODE VIDEO IN COMPLIANCE WITH THE AVC STANDARD (“AVC VIDEO”) AND/OR  
(ii) DECODE AVC VIDEO THAT WAS ENCODED BY A CONSUMER ENGAGED IN A PERSONAL ACTIVITY AND/OR WAS OBTAINED FROM A VIDEO PROVIDER LICENSED TO PROVIDE AVC VIDEO.  
NO LICENSE IS GRANTED OR SHALL BE IMPLIED FOR ANY OTHER USE. ADDITIONAL INFORMATION MAY BE OBTAINED FROM MPEG LA, L.L.C. SEE [HTTP://WWW.MPEGLA.COM](http://www.mpegla.com)
- MPEG LA MPEG-2 Patent  
ANY USE OF THIS UNIT IN ANY MANNER OTHER THAN PERSONAL USE THAT COMPLIES WITH THE MPEG-2 STANDARD FOR ENCODING VIDEO INFORMATION FOR PACKAGED MEDIA IS EXPRESSLY PROHIBITED WITHOUT A LICENSE UNDER APPLICABLE PATENTS IN THE MPEG-2 PATENT PORTFOLIO, WHICH LICENSE IS AVAILABLE FROM MPEG LA, LLC, 6312 S. WHICH LICENSE IS AVAILABLE FROM MPEG LA, LLC, 6312 S. Fiddlers Green circle, Suite 400E, Greenwood Village, Colorado 80111 U.S.A.

## Others

- Do not insert objects other than the memory card into the card slot.
- Do not block the vent on the unit. Blocking of the vent causes internal heating and may lead to burns and fires.
- Do not turn off the [POWER ON/OFF] switch or remove the power cable during recording or playback.
- The camera recorder may not show stable pictures for a few seconds immediately after the power is turned on, but this is not a malfunction.
- When the video signal output terminals are not in use, put on the covers to prevent damage to the terminals.
- Do not drop this unit or subject it to strong impact or vibration as it is a precision equipment.
- Optical performance of lens  
Due to the optical performance of the lens, color divergence phenomena (magnification chromatic aberration) may occur at the periphery of the image. This is not a camera malfunction.
- Noise may appear in the image when switching modes.

# Specifications

## General

- If placed on its side, heat release efficiency will deteriorate.
- Use the supplied AC adapter as the power supply. Do not use the supplied AC adapter on other devices.
- Use the supplied power cord. And do not use the supplied power cord for any other devices.
- When the connectors that come with connector covers are not in use, put on the covers to prevent damage to the connectors.
- This camera recorder makes use of fonts by Fontworks Inc.
- This camera recorder makes use of M+ FONTS.
- Use the built-in wireless LAN only in the country and region where it was purchased.  
And there are legal restrictions on the use and outdoor use depending on the country and region. Please be careful not to violate the law.

**550**

### Content of this manual

- All rights reserved by JVC KENWOOD Corporation. Unauthorized duplication or reprinting of this manual, in whole or in part, is strictly prohibited.
- Illustrated designs, specifications and other contents of this manual are subject to change for improvement without prior notice.
- SDXC and SDHC logos are trademarks of SD-3C, LLC.
- The terms HDMI and HDMI High-Definition Multimedia Interface, and the HDMI Logo are trademarks or registered trademarks of HDMI Licensing Administrator, Inc. in the United States and other countries.
- QuickTime, Final Cut Pro, iPhone, iPad, iPod touch, macOS and Safari are trademarks of Apple Inc., registered in the U.S. and other countries.
- iOS is a trademark or registered trademark of Cisco in the U.S. and other countries and is used under license.
- Android and Google Chrome are trademarks and/or registered trademarks of Google LLC.
- QR Code is a registered trademark of Denso Wave Incorporated.
- Microsoft, Windows, and Internet Explorer are either registered trademarks or trademarks of Microsoft Corporation in the United States and/or other countries.
- The company name of Fontworks, Fontworks, and the name of the fonts are registered trademarks of Fontworks Inc.
- Zixi and the Zixi logo are trademarks of Zixi LLC.
- Other product and company names included in this instruction manual are trademarks and/or registered trademarks of their respective companies. Marks such as <sup>TM</sup> and ® have been omitted in this manual.

Item	Description	
Power	DC 12 V	
Power consumption	Approx. 24.0 W (When recording in the factory default settings using the viewfinder.)	
Mass	Approx. 3.6 kg (With battery attached)	
Allowable operating temperature	0 °C to 40 °C (32 °F to 104 °F)	
Allowable operating humidity	30 %RH to 80 %RH	
Allowable storage temperature	-20 °C to 50 °C (-4 °F to 122 °F)	
Built-in wireless LAN	IEEE802.11a/b/g/n/ac (2.4 GHz/5 GHz band) Encryption method: WPA2	
<b>550</b>		
U model	2.4 GHz	Ch1, 2, 3, 4, 5, 6, 7, 8, 9, 10, 11
	5 GHz USA	Ch36, 40, 44, 48, 52, 56, 60, 64, 100, 104, 108, 112, 116, 120, 124, 128, 132, 136, 140, 149, 153, 157, 161, 165
	5 GHz CANADA	Ch36, 40, 44, 48, 52, 56, 60, 64, 100, 104, 108, 112, 116, 132, 136, 140, 149, 153, 157, 161, 165
E model	2.4 GHz	Ch1, 2, 3, 4, 5, 6, 7, 8, 9, 10, 11, 12, 13
	5 GHz Outside Russia	Ch36, 40, 44, 48, 52, 56, 60, 64, 100, 104, 108, 112, 116, 120, 124, 128, 132, 136, 140
	5 GHz Russia	Ch36, 40, 44, 48, 52, 56, 60, 64, 132, 136, 140, 149, 153, 157, 161, 165



## Terminal Section

### Video/Audio

Item	Description
[SDI OUT] terminal (480i or 576i: Downconverted 720p/1080i/1080p: embedded audio), BNC (unbalanced)	
3G-SDI, HD-SDI, SD-SDI	Compliant with SMPTE ST424, Compliant with SMPTE ST292, Compliant with SMPTE ST259
3G-SDI, HD-SDI, SD-SDI Embedded audio standard	Compliant with SMPTE ST299, Compliant with SMPTE ST299, Compliant with SMPTE ST272
[HDMI] output terminal	Type A
[INPUT 1/INPUT 2] Terminal (XLR 3-pin)	
[MIC]	-50 dBu, 3 k $\Omega$ , XLR (balanced), +48 V output (phantom power supply)
[LINE]	+4 dBu, 10 k $\Omega$ , XLR (balanced)
[AUX] terminal	-22 dBu, 10 k $\Omega$ , 3.5 mm stereo mini jack (unbalanced)
[Q] Terminal	$\Phi$ 3.5 mm stereo mini jack

### Others

Item	Description
[LAN] terminal (RJ-45)	100BASE-TX/1000BASE-T
[HOST] terminal	USB-A type, network connection function only
[REMOTE] terminal	$\Phi$ 2.5 mm mini jack (Stereo)
[TC IN/OUT] terminal	
[IN]	1.0 V (p-p) to 4.0 V (p-p) high impedance
[OUT]	2.0 $\pm$ 1.0 V (p-p) low impedance

### Camera Section

Item	Description
Image pickup device	1" single CMOS sensor (effective resolution: approx. 9.35 megapixels)
Sync system	Internal sync (built-in SSG)
ND filter	OFF, 1/4, 1/16, 1/64
Gain	-6 dB, -3 dB, 0 dB, 3 dB, 6 dB, 9 dB, 12 dB, 15 dB, 18 dB, 21 dB, 24 dB, Lolux (30 dB, 36 dB), AGC
Electronic shutter	1/6 to 1/10000, EEI
LCD Monitor	3.97" LCD (800x480)
Viewfinder	0.4" 4:3 Quad-VGA (1280x960)
Lens	F2.8 to F4.5, 20x zoom, f = 9.43 mm to 188.6 mm (35 mm equivalent: 28.0 mm to 560.0 mm)
Filter diameter	$\Phi$ 82 mm
Sensitivity	F11, 2000 lx (standard value: 60 Hz)

## Storage Section

Item	Description
Supported media	SDHC/SDXC: SD slots x 2 M.2 SSD: Expansion slot

## Video/Audio

Item	Description
4K EXT mode (Apple ProRes)	
Recording file format	QuickTime File Format
Video	
422HQ mode	Apple ProRes 422 HQ, 1768 Mbps (Max), 3840x2160/59.94p, 50p, 29.97p, 23.98p, 25p
422 mode	Apple ProRes 422, 1178 Mbps (Max), 3840x2160/59.94p, 50p, 29.97p, 23.98p, 25p
422LT mode	Apple ProRes 422 LT, 821 Mbps (Max), 3840x2160/59.94p, 50p, 29.97p, 23.98p, 25p
Audio	LPCM 2ch, 48 kHz/24 bit
4K mode (MOV: H.264)	
Recording file format	QuickTime File Format
Video	
<b>4:2:2 10</b> XHQ mode	MPEG-4 AVC/H.264, 150 Mbps (Max) 3840x2160/29.97p, 23.98p, 25p
XHQ mode	MPEG-4 AVC/H.264, 150 Mbps (Max) 3840x2160/29.97p, 23.98p, 25p MPEG-4 AVC/H.264, 70 Mbps (Max) 3840x2160/29.97p, 23.98p, 25p
Audio	LPCM 2ch, 48 kHz/16 bit, 24 bit (422 10 bit only)

Item	Description
HD mode (MOV/MXF: MPEG-2) <b>550</b>	
Recording file format	QuickTime File Format (MOV), MXF File Format (MXF)
Video	
HQ mode	MPEG-2 Long GOP VBR, 35 Mbps (Max) MP@HL, 1920x1080/59.94i, 29.97p, 50i, 25p 1440x1080/59.94i, 50i 1280x720/59.94p, 50p
SP mode	MPEG-2 Long GOP CBR, 25 Mbps (Max) MP@H14 1440x1080/59.94i, 50i
Audio	LPCM 2ch, 48 kHz/16 Bit
HD mode (MOV: H.264)	
Recording file format	QuickTime File Format
Video	
<b>4:2:2 10</b> XHQ mode	MPEG-4 AVC/H.264, 70 Mbps (Max) 1920x1080/59.94p, 50p MPEG-4 AVC/H.264, 50 Mbps (Max) 1920x1080/59.94p, 59.94i, 29.97p, 23.98p, 50p, 50i, 25p 1280x720/59.94p, 50p
XHQ mode	MPEG-4 AVC/H.264, 50 Mbps (Max) 1920x1080/59.94p, 59.94i, 29.97p, 23.98p, 50p, 50i, 25p
UHQ mode	MPEG-4 AVC/H.264, 35 Mbps (Max) 1920x1080/59.94i, 29.97p, 23.98p, 50i, 25p 1280x720/59.94p, 50p
Audio	LPCM 2ch, 48 kHz/16 Bit, 24 Bit (422 10 bit only)

Item	Description
HD mode (Exchange (U model) / MP4 (E model): H.264)	
Recording file format	MP4 File Format
Video	
LP mode	MPEG-4 AVC/H.264, 12 Mbps (Max) 1920x1080/59.94p (U model), 1920x1080/50p (E model), MPEG-4 AVC/H.264, 8 Mbps (Max) 1280x720/59.94p (U model) 1280x720/50p (E model)
Audio	AAC 2ch, 48 kHz/16 Bit 128 kbps
HD mode (High-Speed)	
Recording file format	QuickTime File Format
Video	
<b>4:2:2 HQ</b> XHQ mode	MPEG-4 AVC/H.264, 70 Mbps (Max), 1920x1080 119.88/59.94p, 100/50p MPEG-4 AVC/H.264, 50 Mbps (Max), 1920x1080 119.88/59.94p, 100/50p, 119.88/29.97p, 100/25p, 119.88/23.98p
XHQ mode	MPEG-4 AVC/H.264, 50 Mbps (Max), 1920x1080 119.88/59.94p, 100/50p, 119.88/29.97p, 100/25p, 119.88/23.98p
UHQ mode	MPEG-4 AVC/H.264, 35 Mbps (Max), 1920x1080 119.88/29.97p, 100/25p, 119.88/23.98p
Audio	LPCM 2ch, 48 kHz/16 Bit, 24 Bit (422 10 bit only)

Item	Description
SD mode (MOV: H.264)	
Recording file format	QuickTime File Format
Video	MPEG-4 AVC/H.264, 8 Mbps (Max) 720x480/59.94i (U model) 720x576/50i (E model)
Audio	LPCM 2ch, 48 kHz/16bit
Web mode (MOV: H.264)	
Recording file format	QuickTime File Format
Video	
HQ mode	MPEG-4 AVC/H.264, 8 Mbps (Max) 720x480/59.94i, 720x576/50i MPEG-4 AVC/H.264, 3 Mbps (Max) 960x540/29.97p, 25p, 23.98p
LP mode	MPEG-4 AVC/H.264, 1.2 Mbps (Max) 480x270/29.97p, 25p, 23.98p
Audio	LPCM 2ch, 48 kHz/16 Bit (720x480, 720x576) μ-law 2ch, 16 kHz (960x540, 480x270)
Streaming mode	
Video	MPEG-4 AVC/H.264 1920x1080/59.94p, 50p 24/20/16/12/8 Mbps (Max) 1920x1080/59.94i, 50i, 29.97p, 25p 20/16/12/8/5/3 Mbps (Max) 1280x720/59.94p, 50p 20/16/12/8/5/3 Mbps (Max) 1280x720/29.97p, 25p 8/5/3/1.5 Mbps (Max) 720x480/59.94i 720x576/50i 8/5/3/1.5/0.8/0.3 Mbps (Max) 640x360/59.94p, 50p 3/1.5 Mbps (Max) 640x360/29.97p, 25p 3/1.5/0.8/0.3 Mbps (Max)
Audio	AAC 2ch, 128/64 kbps

## Dimensional Outline Drawing (Unit: mm)

Wireless LAN antenna is not included in GY-HC500U/GY-HC500E/GY-HC500SPCU.

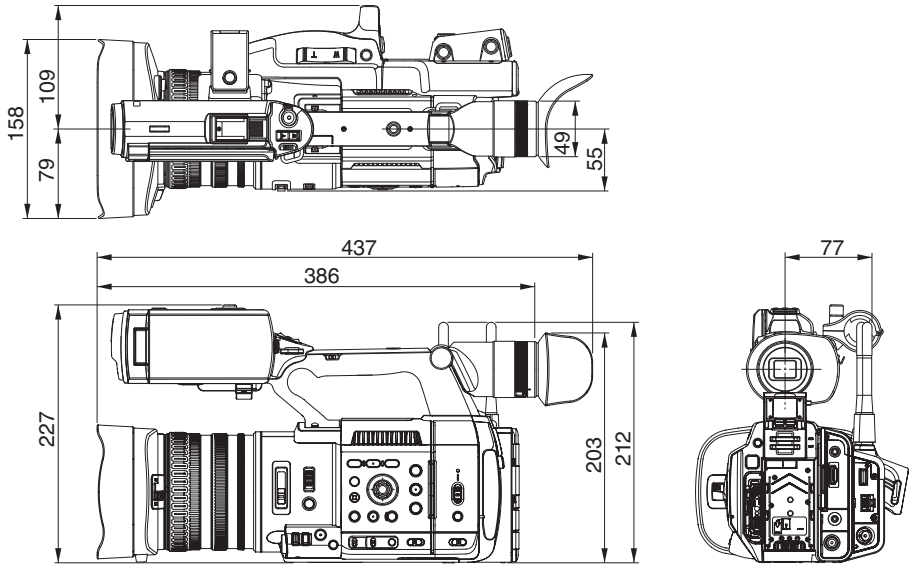

\* The specifications and appearance of this product are subject to changes for further improvement without prior notice.

# Software License Agreement

The software embedded in the Product (hereinafter the “Licensed Software”) provided by JVC KENWOOD Corporation (hereinafter the “Licensor”) is copyrighted to or sublicensable by the Licensor, and this Agreement provides for the terms and conditions which Users shall follow in order to use the Licensed Software. The User shall use the Licensed Software by agreeing with the terms of this Software License Agreement. This Agreement shall be deemed completed at the time the User (hereinafter the “User”) initially used the Product in which the “Licensed Software” is embedded.

The Licensed Software may include the software which has been licensed to the Licensor directly or indirectly from any third party. In such case, some third parties require the Users to follow their conditions for use separately from this Software License Agreement. Such software shall not be subject to this Agreement, and the Users are urged to read the “Important Notice concerning the Software” to be provided separately.

## Article 1 General Provision

The Licensor shall grant to the User a non-exclusive and non-transferable (other than the exceptional case referred to in Article 3, Paragraph 1) licensed to use the Licensed Software within the country of the User (the country where the User bought the Product (hereinafter the “Country”).

## Article 2 License

1. The license granted under this Agreement shall be the right to use the Licensed Software in the Product.
2. The User shall not duplicate, copy, modify, add, translate or otherwise alter, or lease the Licensed Software and any related documents, whether in whole or in part.
3. The use of the Licensed Software shall be limited to personal purpose, and the Licensed Software shall not be distributed, licensed or sub-licensed whether it is for commercial purpose or not.
4. The User shall use the Licensed Software according to the directions described in the operation manual or help file, and is prohibited to use or duplicate any data in a manner violating the Copyright Law or any other laws and regulations by applying whole or a part of the Licensed Software.

## Article 3 Conditions for Grant of License

1. When the User transfers the Product, it may also transfer the license to use the Licensed Software embedded in the Product (including any related materials, updates and upgrades) on condition that no original, copies or related materials continue in the possession of the User, and that the User shall cause the transferee to comply with this Software License Agreement.

2. The User shall not carry out reverse engineering, disassembling, decompiling or any other code analysis works in connection with the Licensed Software.

## Article 4 Right pertaining to the Licensed Software

1. Any and all copyrights and other rights pertaining to the Licensed Software and related documents shall belong to the Licensor or the original holder of the right who granted to the Licensor the license or sublicense for the Licensed Software (hereinafter the “Original Rightholder”), and the User shall not be entitled to any right other than the license granted hereunder, in respect of the Licensed Software and any related documents.
2. The User shall, whenever the User uses the Licensed Software, comply with any laws relating to the copyright and other intellectual property rights.

## Article 5 Indemnification of Licensor

1. Neither the Licensor nor the Original Rightholder shall be liable for any damage incurred by the User or any third party due to the exercise of the license granted to the User under this Agreement, unless otherwise restricted by law.
2. The Licensor will offer no guarantee for the merchantability, convertibility and consistency with certain objective of the Licensed Software.

## Article 6 Liability to Third Party

If any dispute has arisen with any third party due to an infringement upon a copyright, patent or any other intellectual property right that was caused by the User’s use of the Licensed Software, the User shall settle such dispute at the User’s own cost and hold the Licensor and the Original Rightholder harmless from any inconvenience it may cause.

## Article 7 Confidentiality

The User shall keep the confidentiality of such portion of the Licensed Software, related documents thereof or any other information to be granted under this Agreement, as well as the conditions of this Agreement as has not yet entered the public domain, and shall not disclose or divulge the same to any third party without approval of the Licensor.

## Article 8 Termination

In case the User falls under any of the events described in the following items, the Licensor may immediately terminate this Agreement or claim that the User compensates for the damage incurred by the Licensor due to such event:

- (1) when the User violated any provision of this Agreement; or
- (2) when a petition has been filed against the User for an attachment, provisional attachment, provisional disposition or any other compulsory execution.

## Article 9 Destruction of the Licensed Software

If this Agreement is terminated pursuant to the provision of Article 8, the User shall destroy the Licensed Software, any related documents and copies thereof within two (2) weeks from such date of termination.

## Article 10 Export Restriction

1. The User shall understand that the Licensed Software shall be subject to the export restrictions adopted by the country of User and any other countries.
2. The User shall agree that the software will be subject to any and all applicable international and domestic laws including the export control regulation of the country of User and any other countries, and any restrictions concerning the end-users, the use by end-users and importing countries to be provided by the country of User and any other countries, and any other governmental authorities.
3. If the User is an agency of the United States of America (the "Government"), the User acknowledge Licensor's representation that the Licensed Software is a "Commercial Item" as defined in Federal Acquisition Regulation (FAR) part 2.101(g) consisting unpublished "Commercial Computer Software" as those items are used at FAR part 12.212 and is only license the User with the same use right Licensor grants all commercial end users pursuant to the terms of this Agreement.

## Article 11 Miscellaneous

1. In the event any part of this Agreement is invalidated by operation of law, the residual provisions shall continue in force.
2. Matters not stipulated in this Agreement or any ambiguity or question raised in the construction of this Agreement shall be provided or settled upon good-faith consultation between the Licensor and the User.
3. The Licensor and the User hereby agree that this Agreement is governed by the laws of Japan, and any dispute arising from, and relating to the rights and obligations under, this Agreement shall be submitted to the exclusive jurisdiction of the Tokyo District Court for its first instance.

# Important Notice concerning the Software

## Software License Attached to the Product :

The Software embedded in the Product is composed of several independent software components, and in each of such individual components (hereinafter the "Licensed Software"), a copyright of either JVC KENWOOD Corporation (hereinafter "JKC") or a third party subsists.

The Product uses the software component designated in the End-User License Agreement that was executed between JKC and a third party (hereinafter "EULA"). The Licensed Software covers those corresponding to free software, and, as a condition of distribution of the software component in executable format which is based on the license granted under the GNU General Public License or Lesser General Public License (hereinafter "GPL/LGPL"), it requires an availability of the source code for the relevant component. Please refer to the following URL concerning the distribution of the source code;

<https://www3.jvckenwood.com/english/download/gpl/index.html>

Please note that we are unable to answer any inquiry relating to the contents, etc. of the source code. In addition, the Licensed Software includes the software developed or created independently by JKC and there exists an ownership of JKC in such software and any accompanying documents, which is protected by the Copyright Law, any international treaties and other applicable laws. As to matters concerning the handling by JKC of the software components, please refer to the "Software License Agreement" attached hereto. Please note that any software component licensed under "EULA" which is not subject to "GPL/LGPL", and those developed or created independently by JKC shall not be subject to the requirement for provision of the source code. The software component distributed under "GPL/LGPL" shall be licensed to users without charge, and, therefore, no warranty is given for such software component, either express or implied, within the scope of the applicable laws and regulations. Unless otherwise permitted by applicable laws and regulations or agreed in written form, none of the owners of the copyright or persons entitled to alter or redistribute the software component under the said license shall have any liability for any type of damage or loss resulting from the use of or inability to use such software component. For further details of the conditions of use of such software component or matters required to be complied with, please refer to the relevant "GPL/LGPL". Users are urged to read the details for the relevant license carefully before using the software component covered by "GPL/LGPL" and embedded in the Product. Since the terms and conditions of individual licenses are provided by parties other than JKC, the original English version will be displayed by the Product.

- ① Turn on the power.
- ② Press the [MENU/THUMB] button.
- ③ Select [System] → [System Information] → [Open Source License].



GY-HC550U/GY-HC550E  
GY-HC500U/GY-HC500E  
GY-HC500SPCU  
4K MEMORY CARD CAMERA RECORDER

**JVC**